

# D900 LOFT

Produktumfang / Product range / Gamme des produits / Productomvang

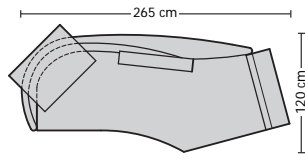

900.27 L

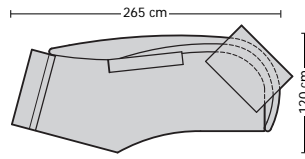

900.27 R

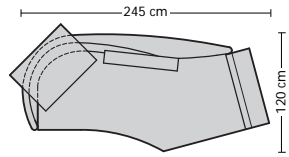

900.25 L

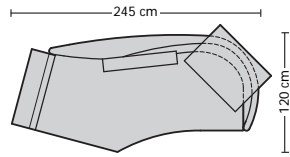

900.25 R

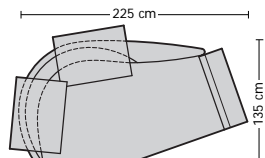

900.29 L

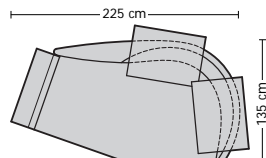

900.29 R

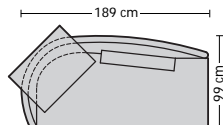

900.24 L

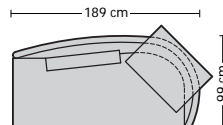

900.24 R

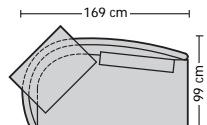

900.20 L

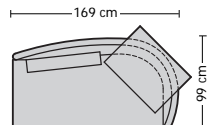

900.20 R

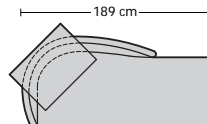

900.22 L

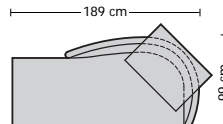

900.22 R

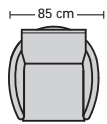

900.17

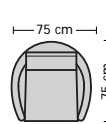

900.16

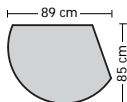

900.64 L  
Hocker

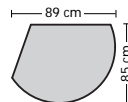

900.64 R  
Hocker

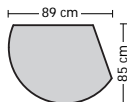

900.648 L  
Tischhocker

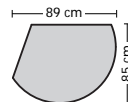

900.648 R  
Tischhocker

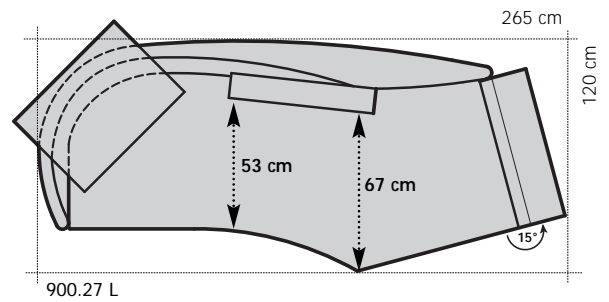

900.27 L

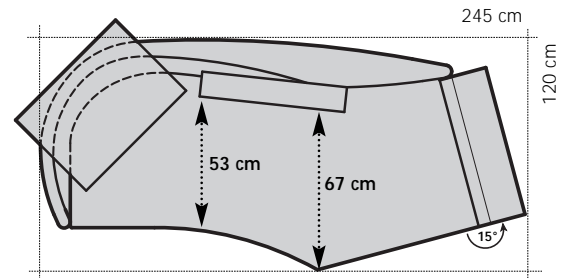

900.25 L

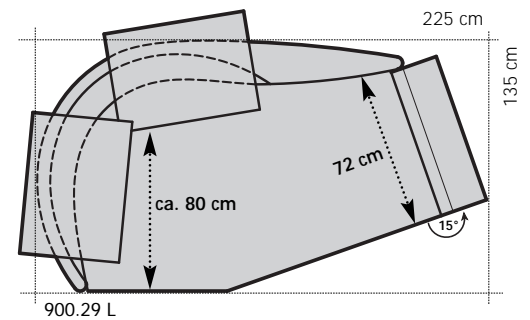

900.29 L

## Kombinationsbeispiele / Arrangements

Exemples de composition / Combinatie voorbeelden

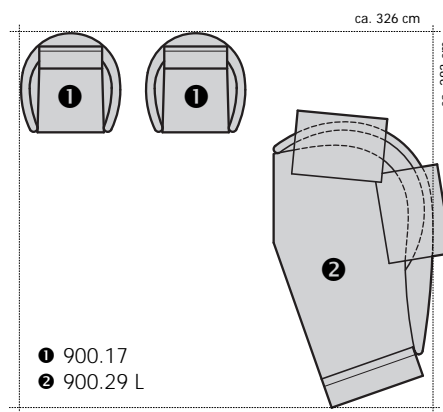
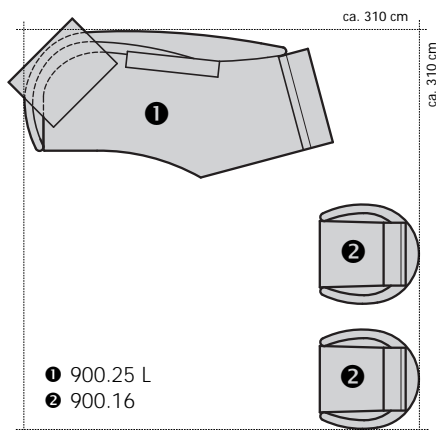
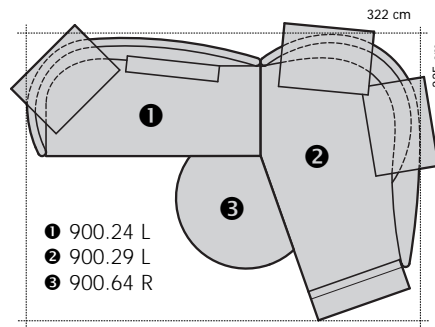
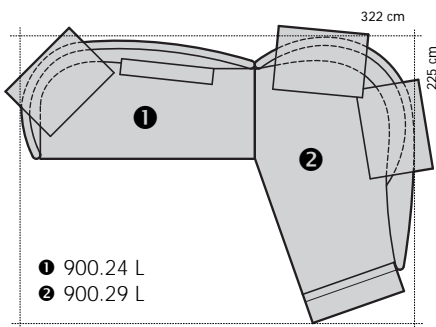
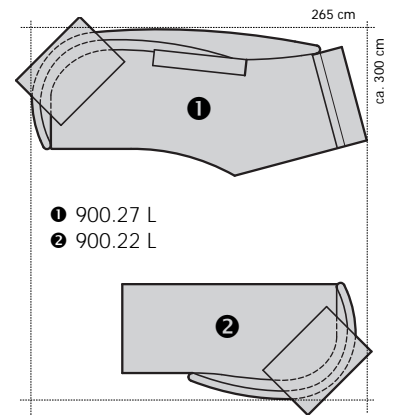
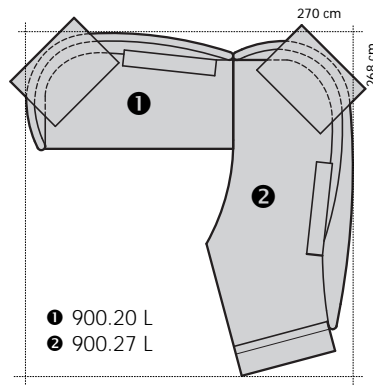
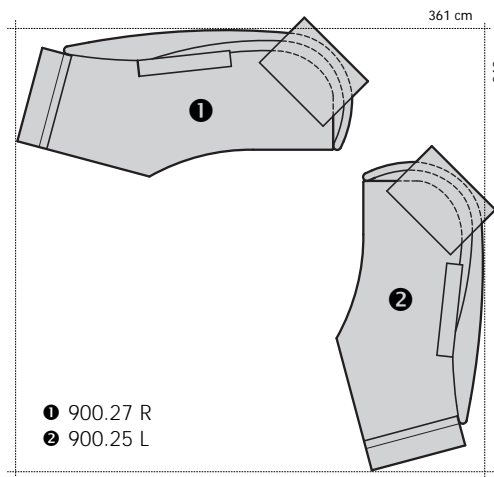

### Berechnung des Breitenstellmaßes

Sofas D900.20 und D900.24 bei Kombinationen mit Anreihsofas D900.25 und D900.27  
Breite Sofa + Tiefe Anreihsofa -19 cm

Calculating the width dimension





Sofas D900.20 and D900.24 when combined with add-on sofas D900.25 and D900.27  
Width of sofa + depth of add-on sofa -19cm

Calcul de la largeur d'implantation

Canapés D900.20 et 900.24 pour les compositions avec canapés juxtaposables D900.25 et D900.27  
largeur canapé + profondeur canapé juxtaposable -19 cm

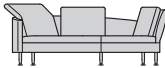
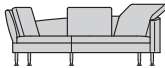
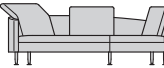
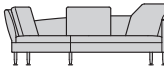
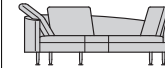

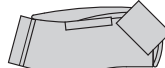
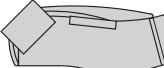
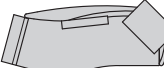



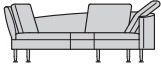
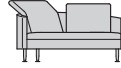
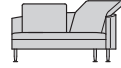
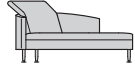
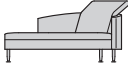
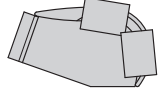
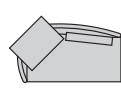
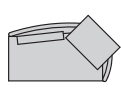
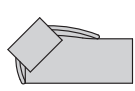
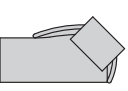

Berekening van de breedtestelmaat

Sofa's D900.20 en D900.24 bij combinaties met aanbouwsofa's D900.25 en D900.27  
Breedte sofa + diepte aanbouwsofa -19 cm

					
					
	Anreihsofa links 2 1/2-sitzig	Anreihsofa rechts 2 1/2-sitzig	Anreihsofa links 2 1/2-sitzig	Anreihsofa rechts 2 1/2-sitzig	Sofa links 2 1/2-sitzig
<b>Breite</b> / Width / Largeur / Breedte	227 cm	227 cm	252 cm	252 cm	213 cm
<b>Tiefe</b> / Depth / Profondeur / Diepte	113 cm	113 cm	113 cm	113 cm	121 cm
<b>Höhe</b> / Height / Hauteur / Hoogte	74 cm	74 cm	74 cm	74 cm	74 cm
<b>Sitzhöhe</b> / Seat height / Hauteur de siège / Zithoogte	43 cm	43 cm	43 cm	43 cm	43 cm
<b>Sitztiefe</b> / Seat depth / Profondeur siège / Zitdiepte	57 - 69 cm	57 - 69 cm	57 - 69 cm	57 - 69 cm	57 - 87 cm
<b>Bestell-Nr.</b> / Order no. / N° de commande / Ordernu.	<b>D900.25 L</b>	<b>D900.25 R</b>	<b>D900.27 L</b>	<b>D900.27 R</b>	<b>D900.29 L</b>
<b>Stoffgruppe</b>	12 <b>2675</b>	<b>2675</b>	<b>2750</b>	<b>2750</b>	<b>2575</b>
Fabric category	13 <b>2695</b>	<b>2695</b>	<b>2795</b>	<b>2795</b>	<b>2675</b>
Catégorie de tissu	14 <b>2750</b>	<b>2750</b>	<b>2875</b>	<b>2875</b>	<b>2725</b>
Stofgroep	15 <b>2795</b>	<b>2795</b>	<b>2950</b>	<b>2950</b>	<b>2775</b>
	16 <b>2850</b>	<b>2850</b>	<b>2995</b>	<b>2995</b>	<b>2875</b>
	17 <b>2950</b>	<b>2950</b>	<b>3075</b>	<b>3075</b>	<b>2950</b>
	18 <b>2975</b>	<b>2975</b>	<b>3175</b>	<b>3175</b>	<b>2995</b>
	19 <b>3175</b>	<b>3175</b>	<b>3675</b>	<b>3675</b>	<b>3175</b>
	20 <b>3275</b>	<b>3275</b>	<b>3775</b>	<b>3775</b>	<b>3275</b>
<b>Avantgarde</b>	<b>2975</b>	<b>2975</b>	<b>3175</b>	<b>3175</b>	<b>2995</b>
<b>Ledergruppe</b>	Derby <b>3775</b>	<b>3775</b>	<b>3975</b>	<b>3975</b>	<b>3875</b>
Leather category	Touch <b>3875</b>	<b>3875</b>	<b>4175</b>	<b>4175</b>	<b>3975</b>
Catégorie de cuir	Premium <b>3975</b>	<b>3975</b>	<b>4275</b>	<b>4275</b>	<b>4075</b>
Leergroep	Nature <b>4275</b>	<b>4275</b>	<b>4575</b>	<b>4575</b>	<b>4575</b>
	Imperial <b>4775</b>	<b>4775</b>	<b>5275</b>	<b>5275</b>	<b>4975</b>
<b>Preis bei Stoffzugabe</b>	<b>2595</b>	<b>2595</b>	<b>2675</b>	<b>2675</b>	<b>2495</b>
Price in customer's own fabric					
Prix sans matériau de recouvrement					
Prijs bij eigen stof					
<b>Stoffbedarf, ohne Rapport</b>					
Fabric requirement, without pattern					
Métrage de tissu nécessaire, sans raccord					
Benodigde bekledingsstof zonder rapport					
<b>140 cm breit</b> / wide / large / breedte	8,70 m	8,70 m	9,05 m	9,05 m	9,05 m
<b>130 cm breit</b> / wide / large / breedte	9,65 m	9,65 m	10,05 m	10,05 m	10,00 m

					
					
	Sofa rechts 2 1/2-sitzig	Sofa links 2-sitzig	Sofa rechts 2-sitzig	Longchair links 2 1/2-sitzig	Longchair rechts 2 1/2-sitzig
<b>Breite</b> / Width / Largeur / Breedte	213 cm	159 cm	159 cm	179 cm	179 cm
<b>Tiefe</b> / Depth / Profondeur / Diepte	121 cm	92 cm	92 cm	92 cm	92 cm
<b>Höhe</b> / Height / Hauteur / Hoogte	74 cm	74 cm	74 cm	74 cm	74 cm
<b>Sitzhöhe</b> / Seat height / Hauteur de siège / Zithoogte	43 cm	43 cm	43 cm	43 cm	43 cm
<b>Sitztiefe</b> / Seat depth / Profondeur siège / Zitdiepte	57 - 87 cm	57 cm	57 cm	57 cm	57 cm
<b>Bestell-Nr.</b> / Order no. / N° de commande / Ordernu.	<b>D900.29 R</b>	<b>D900.20 L</b>	<b>D900.20 R</b>	<b>D900.22 L</b>	<b>D900.22 R</b>
<b>Stoffgruppe</b>	12	<b>2575</b>	<b>2075</b>	<b>2075</b>	<b>2175</b>
Fabric category	13	<b>2675</b>	<b>2150</b>	<b>2150</b>	<b>2250</b>
Catégorie de tissu	14	<b>2725</b>	<b>2195</b>	<b>2195</b>	<b>2275</b>
Stofgroep	15	<b>2775</b>	<b>2225</b>	<b>2225</b>	<b>2325</b>
	16	<b>2875</b>	<b>2275</b>	<b>2275</b>	<b>2375</b>
	17	<b>2950</b>	<b>2325</b>	<b>2325</b>	<b>2450</b>
	18	<b>2995</b>	<b>2375</b>	<b>2375</b>	<b>2475</b>
	19	<b>3175</b>	<b>2495</b>	<b>2495</b>	<b>2595</b>
	20	<b>3275</b>	<b>2575</b>	<b>2575</b>	<b>2675</b>
<b>Avantgarde</b>		<b>2995</b>	<b>2375</b>	<b>2375</b>	<b>2475</b>
<b>Ledergruppe</b>	Derby	<b>3875</b>	<b>2975</b>	<b>2975</b>	<b>3175</b>
Leather category	Touch	<b>3975</b>	<b>3175</b>	<b>3175</b>	<b>3275</b>
Catégorie de cuir	Premium	<b>4075</b>	<b>3275</b>	<b>3275</b>	<b>3375</b>
Leergroep	Nature	<b>4575</b>	<b>3575</b>	<b>3575</b>	<b>3675</b>
	Imperial	<b>4975</b>	<b>3875</b>	<b>3875</b>	<b>3875</b>
<b>Preis bei Stoffzugabe</b>		<b>2495</b>	<b>2025</b>	<b>2025</b>	<b>2125</b>
Price in customer's own fabric					
Prix sans matériau de recouvrement					
Prijs bij eigen stof					
<b>Stoffbedarf, ohne Rapport</b>					
Fabric requirement, without pattern					
Métrage de tissu nécessaire, sans raccord					
Benodigde bekledingsstof zonder rapport					
<b>140 cm breit</b> / wide / large / breedte	9,05 m	6,10 m	6,10 m	5,35 m	5,35 m
<b>130 cm breit</b> / wide / large / breedte	10,00 m	6,90 m	6,90 m	6,00 m	6,00 m



					
					
	Hocker links	Hocker rechts	Tischhocker links	Tischhocker rechts	
<b>Breite</b> / Width / Largeur / Breedte	107 cm	107 cm	107 cm	107 cm	
<b>Tiefe</b> / Depth / Profondeur / Diepte	75 cm	75 cm	75 cm	75 cm	
<b>Höhe</b> / Height / Hauteur / Hoogte	43 cm	43 cm	43 / 32 cm	43 / 32 cm	
<b>Sitzhöhe</b> / Seat height / Hauteur de siège / Zithoogte	-	-	-	-	
<b>Sitztiefe</b> / Seat depth / Profondeur siège / Zitdiepte	-	-	-	-	
<b>Bestell-Nr.</b> / Order no. / N° de commande / Ordernu.	<b>D900.64 L</b>	<b>D900.64 R</b>	<b>D900.648 L</b>	<b>D900.648 R</b>	
<b>Stoffgruppe</b>	12 <b>675</b>	13 <b>675</b>	14 <b>925</b>	15 <b>925</b>	
Fabric category	13 <b>695</b>	14 <b>695</b>	15 <b>945</b>	16 <b>945</b>	
Catégorie de tissu	14 <b>705</b>	15 <b>705</b>	16 <b>955</b>	17 <b>955</b>	
Stofgroep	15 <b>715</b>	16 <b>715</b>	17 <b>965</b>	18 <b>965</b>	
	16 <b>715</b>	17 <b>715</b>	18 <b>965</b>	19 <b>965</b>	
	17 <b>725</b>	18 <b>725</b>	19 <b>975</b>	20 <b>975</b>	
	18 <b>750</b>	19 <b>750</b>	20 <b>1000</b>		
	19 <b>795</b>	20 <b>795</b>			
	20 <b>825</b>				
<b>Avantgarde</b>	<b>750</b>	<b>750</b>	<b>1000</b>	<b>1000</b>	
<b>Ledergruppe</b>	Derby <b>825</b>	Touch <b>825</b>	Premium <b>1075</b>	Nature <b>1075</b>	
Leather category	Imperial <b>850</b>				
Catégorie de cuir					
Leergroep					
<b>Preis bei Stoffzugabe</b>	<b>655</b>	<b>655</b>	<b>905</b>	<b>905</b>	
Price in customer's own fabric					
Prix sans matériau de recouvrement					
Prijs bij eigen stof					
<b>Stoffbedarf, ohne Rapport</b>					
Fabric requirement, without pattern					
Métrage de tissu nécessaire, sans raccord					
Benodigde bekledingsstof zonder rapport					
<b>140 cm breit</b> / wide / large / breedte	2,00 m	2,00 m	2,00 m	2,00 m	
<b>130 cm breit</b> / wide / large / breedte	2,10 m	2,10 m	2,10 m	2,10 m	



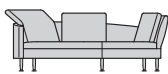
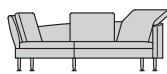

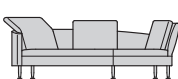
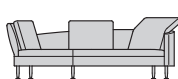

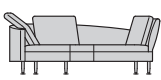
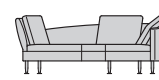
<p><b>Preise für Kombinationen mit unterschiedlichen Bezugsmaterialien. Korpus, Sitz- und Rückenkissen bitte einzeln angeben.</b></p> <p>Please specify in detail when combining different cover materials for body, seat and back cushion.</p> <p>En cas de combinaison, veuillez indiquer séparément les différentes matières de revêtement pour le corps, les coussins de siège et de dossier.</p> <p>Bij combinatie gelieve de verschillende overtrekmaterialen voor de romp, de zit- en rugkussens afzonderlijk te vermelden.</p>							
	Anreihsofa links			Anreihsofa rechts			
	2 1/2-sitzig			2 1/2-sitzig			
	Korpus	Sitzkissen	Rückenkissen	Korpus	Sitzkissen	Rückenkissen	
			D900.930 D900.930 D900.932			D900.930 D900.930 D900.932	
<b>Breite</b> / Width / Largeur / Breedte	227 cm			227 cm			
<b>Tiefe</b> / Depth / Profondeur / Diepte	113 cm			113 cm			
<b>Höhe</b> / Height / Hauteur / Hoogte	74 cm			74 cm			
<b>Sitzhöhe</b> / Seat height / Hauteur de siège / Zithoogte	43 cm			43 cm			
<b>Sitztiefe</b> / Seat depth / Profondeur siège / Zitdiepte	57 - 69 cm			57 - 69 cm			
<b>Bestell-Nr.</b> / Order no. / N° de commande / Ordernu.	<b>D900.25 L</b>	<b>D900.25 L</b>	<b>D900.25 L</b>	<b>D900.25 R</b>	<b>D900.25 R</b>	<b>D900.25 R</b>	
<b>Stoffgruppe</b>	12	<b>1605</b>	<b>595</b>	<b>475</b>	<b>1605</b>	<b>595</b>	<b>475</b>
Fabric category	13	<b>1617</b>	<b>573</b>	<b>505</b>	<b>1617</b>	<b>573</b>	<b>505</b>
Catégorie de tissu	14	<b>1650</b>	<b>575</b>	<b>525</b>	<b>1650</b>	<b>575</b>	<b>525</b>
Stofgroep	15	<b>1677</b>	<b>563</b>	<b>555</b>	<b>1677</b>	<b>563</b>	<b>555</b>
	16	<b>1710</b>	<b>565</b>	<b>575</b>	<b>1710</b>	<b>565</b>	<b>575</b>
	17	<b>1770</b>	<b>585</b>	<b>595</b>	<b>1770</b>	<b>585</b>	<b>595</b>
	18	<b>1785</b>	<b>565</b>	<b>625</b>	<b>1785</b>	<b>565</b>	<b>625</b>
	19	<b>1905</b>	<b>565</b>	<b>705</b>	<b>1905</b>	<b>565</b>	<b>705</b>
	20	<b>1965</b>	<b>535</b>	<b>775</b>	<b>1965</b>	<b>535</b>	<b>775</b>
<b>Avantgarde</b>		<b>1785</b>	<b>565</b>	<b>625</b>	<b>1785</b>	<b>565</b>	<b>625</b>
<b>Ledergruppe</b>	Derby	<b>2265</b>	<b>735</b>	<b>775</b>	<b>2265</b>	<b>735</b>	<b>775</b>
Leather category	Touch	<b>2325</b>	<b>700</b>	<b>850</b>	<b>2325</b>	<b>700</b>	<b>850</b>
Catégorie de cuir	Premium	<b>2385</b>	<b>665</b>	<b>925</b>	<b>2385</b>	<b>665</b>	<b>925</b>
Leergroep	Nature	<b>2565</b>	<b>635</b>	<b>1075</b>	<b>2565</b>	<b>635</b>	<b>1075</b>
	Imperial	<b>2865</b>	<b>710</b>	<b>1200</b>	<b>2865</b>	<b>710</b>	<b>1200</b>
<b>Preis bei Stoffzugabe</b>		<b>1557</b>	<b>578</b>	<b>460</b>	<b>1557</b>	<b>578</b>	<b>460</b>
Price in customer's own fabric							
Prix sans matériau de recouvrement							
Prijs bij eigen stof							
<b>Stoffbedarf, ohne Rapport</b>							
Fabric requirement, without pattern							
Métrage de tissu nécessaire, sans raccord							
Benodigde bekledingsstof zonder rapport							
<b>140 cm breit</b> / wide / large / breedte		4,60 m	2,50 m	3,30 m	4,60 m	2,50 m	3,30 m
<b>130 cm breit</b> / wide / large / breedte		4,60 m	2,50 m	3,30 m	4,60 m	2,50 m	3,30 m

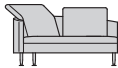
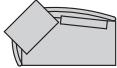
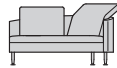
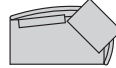



<p><b>Preise für Kombinationen mit unterschiedlichen Bezugsmaterialien. Korpus, Sitz- und Rückenkissen bitte einzeln angeben.</b></p> <p>Please specify in detail when combining different cover materials for body, seat and back cushion.</p> <p>En cas de combinaison, veuillez indiquer séparément les différentes matières de revêtement pour le corps, les coussins de siège et de dossier.</p> <p>Bij combinatie gelieve de verschillende overtrekmaterialen voor de romp, de zit- en rugkussens afzonderlijk te vermelden.</p>							
	Anreihsofa links			Anreihsofa rechts			
	Korpus	Sitzkissen	Rückenkissen	Korpus	Sitzkissen	Rückenkissen	
	2-sitzig		2-sitzig				
		D900.930 D900.930 D900.932			D900.930 D900.930 D900.932		
<b>Breite</b> / Width / Largeur / Breedte	252 cm		252 cm				
<b>Tiefe</b> / Depth / Profondeur / Diepte	113 cm		113 cm				
<b>Höhe</b> / Height / Hauteur / Hoogte	74 cm		74 cm				
<b>Sitzhöhe</b> / Seat height / Hauteur de siège / Zithoogte	43 cm		43 cm				
<b>Sitztiefe</b> / Seat depth / Profondeur siège / Zitdiepte	57 - 69 cm		57 - 69 cm				
<b>Bestell-Nr.</b> / Order no. / N° de commande / Ordernr.	<b>D900.27 L</b>	<b>D900.27 L</b>	<b>D900.27 L</b>	<b>D900.27 R</b>	<b>D900.27 R</b>	<b>D900.27 R</b>	
<b>Stoffgruppe</b>	12	<b>1650</b>	<b>625</b>	<b>475</b>	<b>1650</b>	<b>625</b>	<b>475</b>
Fabric category	13	<b>1677</b>	<b>613</b>	<b>505</b>	<b>1677</b>	<b>613</b>	<b>505</b>
Catégorie de tissu	14	<b>1725</b>	<b>625</b>	<b>525</b>	<b>1725</b>	<b>625</b>	<b>525</b>
Stofgroep	15	<b>1770</b>	<b>625</b>	<b>555</b>	<b>1770</b>	<b>625</b>	<b>555</b>
	16	<b>1797</b>	<b>623</b>	<b>575</b>	<b>1797</b>	<b>623</b>	<b>575</b>
	17	<b>1845</b>	<b>635</b>	<b>595</b>	<b>1845</b>	<b>635</b>	<b>595</b>
	18	<b>1905</b>	<b>645</b>	<b>625</b>	<b>1905</b>	<b>645</b>	<b>625</b>
	19	<b>2205</b>	<b>765</b>	<b>705</b>	<b>2205</b>	<b>765</b>	<b>705</b>
	20	<b>2265</b>	<b>735</b>	<b>775</b>	<b>2265</b>	<b>735</b>	<b>775</b>
<b>Avantgarde</b>		<b>1905</b>	<b>645</b>	<b>625</b>	<b>1905</b>	<b>645</b>	<b>625</b>
<b>Ledergruppe</b>	Derby	<b>2385</b>	<b>815</b>	<b>775</b>	<b>2385</b>	<b>815</b>	<b>775</b>
Leather category	Touch	<b>2505</b>	<b>820</b>	<b>850</b>	<b>2505</b>	<b>820</b>	<b>850</b>
Catégorie de cuir	Premium	<b>2565</b>	<b>785</b>	<b>925</b>	<b>2565</b>	<b>785</b>	<b>925</b>
Leergroep	Nature	<b>2745</b>	<b>755</b>	<b>1075</b>	<b>2745</b>	<b>755</b>	<b>1075</b>
	Imperial	<b>3165</b>	<b>910</b>	<b>1200</b>	<b>3165</b>	<b>910</b>	<b>1200</b>
<b>Preis bei Stoffzugabe</b>		<b>1605</b>	<b>610</b>	<b>460</b>	<b>1605</b>	<b>610</b>	<b>460</b>
Price in customer's own fabric							
Prix sans matériau de recouvrement							
Prijs bij eigen stof							
<b>Stoffbedarf, ohne Rapport</b>							
Fabric requirement, without pattern							
Métrage de tissu nécessaire, sans raccord							
Benodigde bekledingsstof zonder rapport							
<b>140 cm breit</b> / wide / large / breedte		4,90 m	2,80 m	3,30 m	4,90 m	2,80 m	3,30 m
<b>130 cm breit</b> / wide / large / breedte		4,90 m	2,80 m	3,30 m	4,90 m	2,80 m	3,30 m





<p><b>Preise für Kombinationen mit unterschiedlichen Bezugsmaterialien. Korpus, Sitz- und Rückenkissen bitte einzeln angeben.</b></p> <p>Please specify in detail when combining different cover materials for body, seat and back cushion.</p> <p>En cas de combinaison, veuillez indiquer séparément les différentes matières de revêtement pour le corps, les coussins de siège et de dossier.</p> <p>Bij combinatie gelieve de verschillende overtrekmaterialen voor de romp, de zit- en rugkussens afzonderlijk te vermelden.</p>							
	Anreihsofa links 2 1/2-sitzig			Anreihsofa rechts 2 1/2-sitzig			
	Korpus	Sitzkissen	Rückenkissen	Korpus	Sitzkissen	Rückenkissen	
			D900.930 D900.932 D900.932			D900.930 D900.932 D900.932	
<b>Breite</b> / Width / Largeur / Breedte	213 cm			213 cm			
<b>Tiefe</b> / Depth / Profondeur / Diepte	121 cm			121 cm			
<b>Höhe</b> / Height / Hauteur / Hoogte	74 cm			74 cm			
<b>Sitzhöhe</b> / Seat height / Hauteur de siège / Zithoogte	43 cm			43 cm			
<b>Sitztiefe</b> / Seat depth / Profondeur siège / Zitdiepte	57 - 87 cm			57 - 87 cm			
<b>Bestell-Nr.</b> / Order no. / N° de commande / Ordernu.	<b>D900.29 L</b>	<b>D900.29 L</b>	<b>D900.29 L</b>	<b>D900.29 R</b>	<b>D900.29 R</b>	<b>D900.29 R</b>	
<b>Stoffgruppe</b>	12	<b>1545</b>	<b>500</b>	<b>530</b>	<b>1545</b>	<b>500</b>	<b>530</b>
Fabric category	13	<b>1605</b>	<b>495</b>	<b>575</b>	<b>1605</b>	<b>495</b>	<b>575</b>
Catégorie de tissu	14	<b>1635</b>	<b>490</b>	<b>600</b>	<b>1635</b>	<b>490</b>	<b>600</b>
Stofgroep	15	<b>1665</b>	<b>465</b>	<b>645</b>	<b>1665</b>	<b>465</b>	<b>645</b>
	16	<b>1725</b>	<b>480</b>	<b>670</b>	<b>1725</b>	<b>480</b>	<b>670</b>
	17	<b>1770</b>	<b>485</b>	<b>695</b>	<b>1770</b>	<b>485</b>	<b>695</b>
	18	<b>1797</b>	<b>473</b>	<b>725</b>	<b>1797</b>	<b>473</b>	<b>725</b>
	19	<b>1905</b>	<b>475</b>	<b>795</b>	<b>1905</b>	<b>475</b>	<b>795</b>
	20	<b>1965</b>	<b>435</b>	<b>875</b>	<b>1965</b>	<b>435</b>	<b>875</b>
<b>Avantgarde</b>		<b>1797</b>	<b>473</b>	<b>725</b>	<b>1797</b>	<b>473</b>	<b>725</b>
<b>Ledergruppe</b>	Derby	<b>2325</b>	<b>675</b>	<b>875</b>	<b>2325</b>	<b>675</b>	<b>875</b>
Leather category	Touch	<b>2385</b>	<b>640</b>	<b>950</b>	<b>2385</b>	<b>640</b>	<b>950</b>
Catégorie de cuir	Premium	<b>2445</b>	<b>605</b>	<b>1025</b>	<b>2445</b>	<b>605</b>	<b>1025</b>
Leergroep	Nature	<b>2745</b>	<b>655</b>	<b>1175</b>	<b>2745</b>	<b>655</b>	<b>1175</b>
	Imperial	<b>2985</b>	<b>715</b>	<b>1275</b>	<b>2985</b>	<b>715</b>	<b>1275</b>
<b>Preis bei Stoffzugabe</b>		<b>1497</b>	<b>483</b>	<b>515</b>	<b>1497</b>	<b>483</b>	<b>515</b>
Price in customer's own fabric							
Prix sans matériau de recouvrement							
Prijs bij eigen stof							
<b>Stoffbedarf, ohne Rapport</b>							
Fabric requirement, without pattern							
Métrage de tissu nécessaire, sans raccord							
Benodigde bekledingsstof zonder rapport							
<b>140 cm breit</b> / wide / large / breedte		4,70 m	2,25 m	3,35 m	4,70 m	2,25 m	3,35 m
<b>130 cm breit</b> / wide / large / breedte		4,70 m	2,25 m	3,35 m	4,70 m	2,25 m	3,35 m

<p><b>Preise für Kombinationen mit unterschiedlichen Bezugsmaterialien. Korpus, Sitz- und Rückenkissen bitte einzeln angeben.</b></p> <p>Please specify in detail when combining different cover materials for body, seat and back cushion.</p> <p>En cas de combinaison, veuillez indiquer séparément les différentes matières de revêtement pour le corps, les coussins de siège et de dossier.</p> <p>Bij combinatie gelieve de verschillende overtrekmaterialen voor de romp, de zit- en rugkussens afzonderlijk te vermelden.</p>	 			 			
	Anreihsofa links			Anreihsofa rechts			
	Korpus	Sitzkissen	Rückenkissen	Korpus	Sitzkissen	Rückenkissen	
	2-sitzig			2-sitzig			
		D900.930 D900.932			D900.930 D900.932		
<b>Breite</b> / Width / Largeur / Breedte	159 cm		159 cm				
<b>Tiefe</b> / Depth / Profondeur / Diepte	92 cm		92 cm				
<b>Höhe</b> / Height / Hauteur / Hoogte	74 cm		74 cm				
<b>Sitzhöhe</b> / Seat height / Hauteur de siège / Zithoogte	43 cm		43 cm				
<b>Sitztiefe</b> / Seat depth / Profondeur siège / Zitdiepte	57 cm		57 cm				
<b>Bestell-Nr.</b> / Order no. / N° de commande / Ordernr.	<b>D900.20 L</b>	<b>D900.20 L</b>	<b>D900.20 L</b>	<b>D900.20 R</b>	<b>D900.20 R</b>	<b>D900.20 R</b>	
<b>Stoffgruppe</b>	12	<b>1390</b>	<b>350</b>	<b>335</b>	<b>1390</b>	<b>350</b>	<b>335</b>
Fabric category	13	<b>1441</b>	<b>350</b>	<b>360</b>	<b>1441</b>	<b>350</b>	<b>360</b>
Catégorie de tissu	14	<b>1471</b>	<b>349</b>	<b>375</b>	<b>1471</b>	<b>349</b>	<b>375</b>
Stofgroep	15	<b>1491</b>	<b>334</b>	<b>400</b>	<b>1491</b>	<b>334</b>	<b>400</b>
	16	<b>1524</b>	<b>336</b>	<b>415</b>	<b>1524</b>	<b>336</b>	<b>415</b>
	17	<b>1558</b>	<b>337</b>	<b>430</b>	<b>1558</b>	<b>337</b>	<b>430</b>
	18	<b>1591</b>	<b>334</b>	<b>450</b>	<b>1591</b>	<b>334</b>	<b>450</b>
	19	<b>1672</b>	<b>323</b>	<b>500</b>	<b>1672</b>	<b>323</b>	<b>500</b>
	20	<b>1725</b>	<b>300</b>	<b>550</b>	<b>1725</b>	<b>300</b>	<b>550</b>
<b>Avantgarde</b>		<b>1591</b>	<b>334</b>	<b>450</b>	<b>1591</b>	<b>334</b>	<b>450</b>
<b>Ledergruppe</b>	Derby	<b>1993</b>	<b>432</b>	<b>550</b>	<b>1993</b>	<b>432</b>	<b>550</b>
Leather category	Touch	<b>2127</b>	<b>448</b>	<b>600</b>	<b>2127</b>	<b>448</b>	<b>600</b>
Catégorie de cuir	Premium	<b>2194</b>	<b>431</b>	<b>650</b>	<b>2194</b>	<b>431</b>	<b>650</b>
Leergroep	Nature	<b>2395</b>	<b>430</b>	<b>750</b>	<b>2395</b>	<b>430</b>	<b>750</b>
	Imperial	<b>2596</b>	<b>454</b>	<b>825</b>	<b>2596</b>	<b>454</b>	<b>825</b>
<b>Preis bei Stoffzugabe</b>		<b>1357</b>	<b>343</b>	<b>325</b>	<b>1357</b>	<b>343</b>	<b>325</b>
Price in customer's own fabric							
Prix sans matériau de recouvrement							
Prijs bij eigen stof							
<b>Stoffbedarf, ohne Rapport</b>							
Fabric requirement, without pattern							
Métrage de tissu nécessaire, sans raccord							
Benodigde bekledingsstof zonder rapport							
<b>140 cm breit</b> / wide / large / breedte		3,35 m	1,75 m	2,50 m	3,35 m	1,75 m	2,50 m
<b>130 cm breit</b> / wide / large / breedte		3,35 m	1,75 m	2,50 m	3,35 m	1,75 m	2,50 m

<p><b>Preise für Kombinationen mit unterschiedlichen Bezugsmaterialien. Korpus, Sitz- und Rückenkissen bitte einzeln angeben.</b></p> <p>Please specify in detail when combining different cover materials for body, seat and back cushion.</p> <p>En cas de combinaison, veuillez indiquer séparément les différentes matières de revêtement pour le corps, les coussins de siège et de dossier.</p> <p>Bij combinatie gelieve de verschillende overtrekmaterialen voor de romp, de zit- en rugkussens afzonderlijk te vermelden.</p>							
	Anreihsofa links			Anreihsofa rechts			
	Korpus	Sitzkissen	Rückenkissen	Korpus	Sitzkissen	Rückenkissen	
	2 1/2-sitzig		2 1/2-sitzig				
		D900.932			D900.932		
<b>Breite</b> / Width / Largeur / Breedte	179 cm		179 cm				
<b>Tiefe</b> / Depth / Profondeur / Diepte	92 cm		92 cm				
<b>Höhe</b> / Height / Hauteur / Hoogte	74 cm		74 cm				
<b>Sitzhöhe</b> / Seat height / Hauteur de siège / Zithoogte	43 cm		43 cm				
<b>Sitztiefe</b> / Seat depth / Profondeur siège / Zitdiepte	57 cm		57 cm				
<b>Bestell-Nr.</b> / Order no. / N° de commande / Ordernu.	<b>D900.22 L</b>	<b>D900.22 L</b>	<b>D900.22 L</b>	<b>D900.22 R</b>	<b>D900.22 R</b>	<b>D900.22 R</b>	
<b>Stoffgruppe</b>	12	<b>1523</b>	<b>458</b>	<b>195</b>	<b>1523</b>	<b>458</b>	<b>195</b>
Fabric category	13	<b>1575</b>	<b>460</b>	<b>215</b>	<b>1575</b>	<b>460</b>	<b>215</b>
Catégorie de tissu	14	<b>1593</b>	<b>458</b>	<b>225</b>	<b>1593</b>	<b>458</b>	<b>225</b>
Stofgroep	15	<b>1628</b>	<b>453</b>	<b>245</b>	<b>1628</b>	<b>453</b>	<b>245</b>
	16	<b>1663</b>	<b>458</b>	<b>255</b>	<b>1663</b>	<b>458</b>	<b>255</b>
	17	<b>1715</b>	<b>470</b>	<b>265</b>	<b>1715</b>	<b>470</b>	<b>265</b>
	18	<b>1733</b>	<b>468</b>	<b>275</b>	<b>1733</b>	<b>468</b>	<b>275</b>
	19	<b>1817</b>	<b>484</b>	<b>295</b>	<b>1817</b>	<b>484</b>	<b>295</b>
	20	<b>1873</b>	<b>478</b>	<b>325</b>	<b>1873</b>	<b>478</b>	<b>325</b>
<b>Avantgarde</b>		<b>1733</b>	<b>468</b>	<b>275</b>	<b>1733</b>	<b>468</b>	<b>275</b>
<b>Ledergruppe</b>	Derby	<b>2223</b>	<b>628</b>	<b>325</b>	<b>2223</b>	<b>628</b>	<b>325</b>
Leather category	Touch	<b>2293</b>	<b>633</b>	<b>350</b>	<b>2293</b>	<b>633</b>	<b>350</b>
Catégorie de cuir	Premium	<b>2363</b>	<b>638</b>	<b>375</b>	<b>2363</b>	<b>638</b>	<b>375</b>
Leergroep	Nature	<b>2573</b>	<b>678</b>	<b>425</b>	<b>2573</b>	<b>678</b>	<b>425</b>
	Imperial	<b>2713</b>	<b>713</b>	<b>450</b>	<b>2713</b>	<b>713</b>	<b>450</b>
<b>Preis bei Stoffzugabe</b>		<b>1488</b>	<b>448</b>	<b>190</b>	<b>1488</b>	<b>448</b>	<b>190</b>
Price in customer's own fabric							
Prix sans matériau de recouvrement							
Prijs bij eigen stof							
<b>Stoffbedarf, ohne Rapport</b>							
Fabric requirement, without pattern							
Métrage de tissu nécessaire, sans raccord							
Benodigde bekledingsstof zonder rapport							
<b>140 cm breit</b> / wide / large / breedte		2,95 m	2,00 m	1,70 m	2,95 m	2,00 m	1,70 m
<b>130 cm breit</b> / wide / large / breedte		2,95 m	2,00 m	1,70 m	2,95 m	2,00 m	1,70 m

<p><b>Preise für Kombinationen mit unterschiedlichen Bezugsmaterialien. Korpus, Sitz- und Rückenkissen bitte einzeln angeben.</b></p> <p>Please specify in detail when combining different cover materials for body, seat and back cushion.</p> <p>En cas de combinaison, veuillez indiquer séparément les différentes matières de revêtement pour le corps, les coussins de siège et de dossier.</p> <p>Bij combinatie gelieve de verschillende overtrekmaterialen voor de romp, de zit- en rugkussens afzonderlijk te vermelden.</p>							
	Anreihsofa links 2 1/2-sitzig			Anreihsofa rechts 2 1/2-sitzig			
	Korpus	Sitzkissen	Rückenkissen	Korpus	Sitzkissen	Rückenkissen	
			D900.930 D900.932			D900.930 D900.932	
<b>Breite</b> / Width / Largeur / Breedte	179 cm			179 cm			
<b>Tiefe</b> / Depth / Profondeur / Diepte	92 cm			92 cm			
<b>Höhe</b> / Height / Hauteur / Hoogte	74 cm			74 cm			
<b>Sitzhöhe</b> / Seat height / Hauteur de siège / Zithoogte	43 cm			43 cm			
<b>Sitztiefe</b> / Seat depth / Profondeur siège / Zitdiepte	57 cm			57 cm			
<b>Bestell-Nr.</b> / Order no. / N° de commande / Ordernu.	<b>D900.24 L</b>	<b>D900.24 L</b>	<b>D900.24 L</b>	<b>D900.24 R</b>	<b>D900.24 R</b>	<b>D900.24 R</b>	
<b>Stoffgruppe</b>	12	<b>1524</b>	<b>416</b>	<b>335</b>	<b>1524</b>	<b>416</b>	<b>335</b>
Fabric category	13	<b>1575</b>	<b>416</b>	<b>360</b>	<b>1575</b>	<b>416</b>	<b>360</b>
Catégorie de tissu	14	<b>1591</b>	<b>409</b>	<b>375</b>	<b>1591</b>	<b>409</b>	<b>375</b>
Stofgroep	15	<b>1658</b>	<b>417</b>	<b>400</b>	<b>1658</b>	<b>417</b>	<b>400</b>
	16	<b>1709</b>	<b>427</b>	<b>415</b>	<b>1709</b>	<b>427</b>	<b>415</b>
	17	<b>1725</b>	<b>420</b>	<b>430</b>	<b>1725</b>	<b>420</b>	<b>430</b>
	18	<b>1792</b>	<b>433</b>	<b>450</b>	<b>1792</b>	<b>433</b>	<b>450</b>
	19	<b>1843</b>	<b>408</b>	<b>500</b>	<b>1843</b>	<b>408</b>	<b>500</b>
	20	<b>1859</b>	<b>366</b>	<b>550</b>	<b>1859</b>	<b>366</b>	<b>550</b>
<b>Avantgarde</b>		<b>1792</b>	<b>433</b>	<b>450</b>	<b>1792</b>	<b>433</b>	<b>450</b>
<b>Ledergruppe</b>	Derby	<b>2194</b>	<b>531</b>	<b>550</b>	<b>2194</b>	<b>531</b>	<b>550</b>
Leather category	Touch	<b>2261</b>	<b>514</b>	<b>600</b>	<b>2261</b>	<b>514</b>	<b>600</b>
Catégorie de cuir	Premium	<b>2328</b>	<b>497</b>	<b>650</b>	<b>2328</b>	<b>497</b>	<b>650</b>
Leergroep	Nature	<b>2529</b>	<b>496</b>	<b>750</b>	<b>2529</b>	<b>496</b>	<b>750</b>
	Imperial	<b>2663</b>	<b>487</b>	<b>825</b>	<b>2663</b>	<b>487</b>	<b>825</b>
<b>Preis bei Stoffzugabe</b>		<b>1491</b>	<b>409</b>	<b>325</b>	<b>1491</b>	<b>409</b>	<b>325</b>
Price in customer's own fabric							
Prix sans matériau de recouvrement							
Prijs bij eigen stof							
<b>Stoffbedarf, ohne Rapport</b>							
Fabric requirement, without pattern							
Métrage de tissu nécessaire, sans raccord							
Benodigde bekledingsstof zonder rapport							
<b>140 cm breit</b> / wide / large / breedte		3.50 m	2.00 m	2.50 m	3.50 m	2.00 m	2.50 m
<b>130 cm breit</b> / wide / large / breedte		3.50 m	2.00 m	2.50 m	3.50 m	2.00 m	2.50 m

<b>Preise für Kombinationen mit unterschiedlichen Bezugsmaterialien. Korpus, Sitz- und Rückenkissen bitte einzeln angeben.</b> Please specify in detail when combining different cover materials for body, seat and back cushion. En cas de combinaison, veuillez indiquer séparément les différentes matières de revêtement pour le corps, les coussins de siège et de dossier. Bij combinatie gelieve de verschillende overtrekmaterialen voor de romp, de zit- en rugkussens afzonderlijk te vermelden.	 			 			
	Sessel			Sessel			
	Korpus	Sitzkissen	Rückenkissen	Korpus	Sitzkissen	Rückenkissen	
		D900.930			D900.930		
<b>Breite</b> / Width / Largeur / Breedte	79 cm		85 cm				
<b>Tiefe</b> / Depth / Profondeur / Diepte	76 cm		88 cm				
<b>Höhe</b> / Height / Hauteur / Hoogte	82 cm		87 cm				
<b>Sitzhöhe</b> / Seat height / Hauteur de siège / Zithoogte	43 cm		43 cm				
<b>Sitztiefe</b> / Seat depth / Profondeur siège / Zitdiepte	47 cm		54 cm				
<b>Bestell-Nr.</b> / Order no. / N° de commande / Ordernu.	<b>D900.16</b>	<b>D900.16</b>	<b>D900.16</b>	<b>D900.17</b>	<b>D900.17</b>	<b>D900.17</b>	
<b>Stoffgruppe</b>	12	<b>735</b>	<b>210</b>	<b>105</b>	<b>900</b>	<b>225</b>	<b>125</b>
Fabric category	13	<b>753</b>	<b>215</b>	<b>108</b>	<b>918</b>	<b>230</b>	<b>128</b>
Catégorie de tissu	14	<b>770</b>	<b>220</b>	<b>110</b>	<b>936</b>	<b>234</b>	<b>130</b>
Stofgroep	15	<b>788</b>	<b>225</b>	<b>113</b>	<b>954</b>	<b>239</b>	<b>133</b>
	16	<b>805</b>	<b>230</b>	<b>115</b>	<b>972</b>	<b>243</b>	<b>135</b>
	17	<b>823</b>	<b>235</b>	<b>118</b>	<b>990</b>	<b>248</b>	<b>138</b>
	18	<b>893</b>	<b>255</b>	<b>128</b>	<b>1062</b>	<b>266</b>	<b>148</b>
	19	<b>928</b>	<b>265</b>	<b>133</b>	<b>1098</b>	<b>275</b>	<b>153</b>
	20	<b>963</b>	<b>275</b>	<b>138</b>	<b>1134</b>	<b>284</b>	<b>158</b>
<b>Avantgarde</b>		<b>893</b>	<b>255</b>	<b>128</b>	<b>1062</b>	<b>266</b>	<b>148</b>
<b>Ledergruppe</b>	Derby	<b>1033</b>	<b>295</b>	<b>148</b>	<b>1206</b>	<b>302</b>	<b>168</b>
Leather category	Touch	<b>1103</b>	<b>315</b>	<b>158</b>	<b>1278</b>	<b>320</b>	<b>178</b>
Catégorie de cuir	Premium	<b>1243</b>	<b>355</b>	<b>178</b>	<b>1422</b>	<b>356</b>	<b>198</b>
Leergroep	Nature	<b>1313</b>	<b>375</b>	<b>188</b>	<b>1494</b>	<b>374</b>	<b>208</b>
	Imperial	<b>1383</b>	<b>395</b>	<b>198</b>	<b>1566</b>	<b>392</b>	<b>218</b>
<b>Preis bei Stoffzugabe</b>		<b>718</b>	<b>205</b>	<b>103</b>	<b>882</b>	<b>221</b>	<b>123</b>
Price in customer's own fabric							
Prix sans matériau de recouvrement							
Prijs bij eigen stof							
<b>Stoffbedarf, ohne Rapport</b>							
Fabric requirement, without pattern							
Métrage de tissu nécessaire, sans raccord							
Benodigde bekledingsstof zonder rapport							
<b>140 cm breit</b> / wide / large / breedte		2,85 m	0,80 m	0,65 m	3,20 m	0,90 m	0,85 m
<b>130 cm breit</b> / wide / large / breedte		2,85 m	0,80 m	0,65 m	3,20 m	0,90 m	0,85 m

<b>Preise für Kombinationen mit unterschiedlichen Bezugsmaterialien. Korpus, Sitz- und Rückenkissen bitte einzeln angeben.</b> Please specify in detail when combining different cover materials for body, seat and back cushion. En cas de combinaison, veuillez indiquer séparément les différentes matières de revêtement pour le corps, les coussins de siège et de dossier. Bij combinatie gelieve de verschillende overtrekmaterialen voor de romp, de zit- en rugkussens afzonderlijk te vermelden.	 			 			
	Sessel mit Tellerfuss			Sessel mit Tellerfuss			
	Korpus	Sitzkissen	Rückenkissen	Korpus	Sitzkissen	Rückenkissen	
		D900.933			D900.933		
<b>Breite</b> / Width / Largeur / Breedte	79 cm		85 cm				
<b>Tiefe</b> / Depth / Profondeur / Diepte	76 cm		88 cm				
<b>Höhe</b> / Height / Hauteur / Hoogte	82 cm		87 cm				
<b>Sitzhöhe</b> / Seat height / Hauteur de siège / Zithoogte	43 cm		43 cm				
<b>Sitztiefe</b> / Seat depth / Profondeur siège / Zitdiepte	47 cm		54 cm				
<b>Bestell-Nr.</b> / Order no. / N° de commande / Ordernu.	<b>D900.16</b>	<b>D900.16</b>	<b>D900.16</b>	<b>D900.17</b>	<b>D900.17</b>	<b>D900.17</b>	
	<b>Tellerfuss</b>	<b>Tellerfuss</b>	<b>Tellerfuss</b>	<b>Tellerfuss</b>	<b>Tellerfuss</b>	<b>Tellerfuss</b>	
<b>Stoffgruppe</b>	12	<b>860</b>	<b>210</b>	<b>105</b>	<b>925</b>	<b>225</b>	<b>125</b>
Fabric category	13	<b>873</b>	<b>215</b>	<b>108</b>	<b>938</b>	<b>230</b>	<b>128</b>
Catégorie de tissu	14	<b>895</b>	<b>220</b>	<b>110</b>	<b>961</b>	<b>234</b>	<b>130</b>
Stofgroep	15	<b>913</b>	<b>225</b>	<b>113</b>	<b>979</b>	<b>239</b>	<b>133</b>
	16	<b>930</b>	<b>230</b>	<b>115</b>	<b>997</b>	<b>243</b>	<b>135</b>
	17	<b>943</b>	<b>235</b>	<b>118</b>	<b>1010</b>	<b>248</b>	<b>138</b>
	18	<b>1013</b>	<b>255</b>	<b>128</b>	<b>1082</b>	<b>266</b>	<b>148</b>
	19	<b>1048</b>	<b>265</b>	<b>133</b>	<b>1118</b>	<b>275</b>	<b>153</b>
	20	<b>1083</b>	<b>275</b>	<b>138</b>	<b>1154</b>	<b>284</b>	<b>158</b>
<b>Avantgarde</b>		<b>1013</b>	<b>255</b>	<b>128</b>	<b>1082</b>	<b>266</b>	<b>148</b>
<b>Ledergruppe</b>	Derby	<b>1153</b>	<b>295</b>	<b>148</b>	<b>1226</b>	<b>302</b>	<b>168</b>
Leather category	Touch	<b>1223</b>	<b>315</b>	<b>158</b>	<b>1298</b>	<b>320</b>	<b>178</b>
Catégorie de cuir	Premium	<b>1363</b>	<b>355</b>	<b>178</b>	<b>1442</b>	<b>356</b>	<b>198</b>
Leergroep	Nature	<b>1433</b>	<b>375</b>	<b>188</b>	<b>1514</b>	<b>374</b>	<b>208</b>
	Imperial	<b>1503</b>	<b>395</b>	<b>198</b>	<b>1586</b>	<b>392</b>	<b>218</b>
<b>Preis bei Stoffzugabe</b>		<b>843</b>	<b>205</b>	<b>103</b>	<b>907</b>	<b>221</b>	<b>123</b>
Price in customer's own fabric							
Prix sans matériau de recouvrement							
Prijs bij eigen stof							
<b>Stoffbedarf, ohne Rapport</b>							
Fabric requirement, without pattern							
Métrage de tissu nécessaire, sans raccord							
Benodigde bekledingsstof zonder rapport							
<b>140 cm breit</b> / wide / large / breedte		2,85 m	0,80 m	0,65 m	3,20 m	0,90 m	0,85 m
<b>130 cm breit</b> / wide / large / breedte		2,85 m	0,80 m	0,65 m	3,20 m	0,90 m	0,85 m

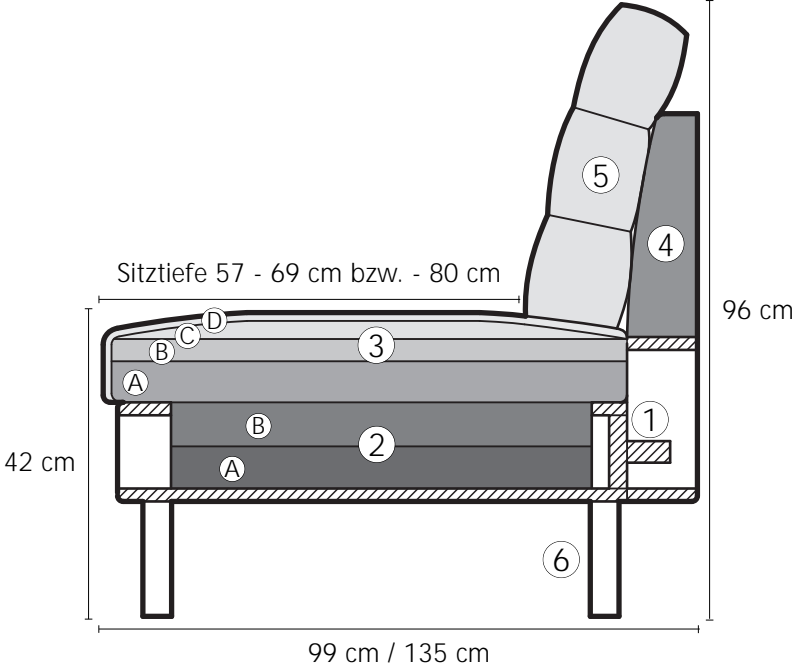

<b>Gestell</b>	Sitz und Rücken in Rahmenkonstruktion aus Schichtholz und massiven Bucherahmen. Gedübelt und verleimt.	<b>Frame</b>	Seat and back frame construction made of plywood and solid beech frames. Doweled and glued.
<b>Unterfederung</b>	Unterfederung aus hochtragfähigem Polyätherschaum <b>A</b> Polyätherschaum, RG 43 / 2,8, <b>B</b> Polyätherschaum, RG 50 / 2,0	<b>Spring base</b>	Highly durable polyether foam <b>A</b> Polyether foam, density 43 / 2.8 <b>B</b> Polyether foam, density 50 / 2.0
<b>Sitzkissen</b>	Vierschichtiger Polsteraufbau <b>A</b> Polyätherschaum, RG 43 / 5,0 <b>B</b> Kaltschaum, RG 42 / 4,5 <b>C</b> Polyätherschaum, RG 40 / 1,4 <b>D</b> Elastische Vliesabdeckung 345 g/m <sup>2</sup>	<b>Seat cushions</b>	Four-layered cushion structure <b>A</b> Polyether foam, density 43 / 5.0 <b>B</b> Cold foam, density 42 / 4.5 <b>C</b> Polyether foam, density 40 / 1.4 <b>D</b> Elastic polyester padding 345 g/m <sup>2</sup>
<b>Rückenkorpus</b>	Dreipunkt Spezialschaum RG 33 / 15,0	<b>Back body</b>	Dreipunkt special foam density 33 / 15.0
<b>Rückenkissen</b>	Kammerkissen mit Daunencharakter. Füllung Dreipunkt Selecta RG 80 (80%) und elastischen Vliesfasern 20%. Zur Pflege empfehlen wir ein regelmässiges Aufschütteln der einzelnen Rückenkissen.	<b>Back cushions</b>	Chambered cushions with a downy character. Filled with Dreipunkt Selecta density 80 (80%) and elastic polyester fibers (20%). The single back cushions should be plumped up on a regular basis.
<b>Fussausführungen</b>	Metall- oder Holzfuss Beim Sessel D900.16 und D900.17 auch mit Aluminium Tellerfuss.	<b>Legs</b>	Metal or wooden legs Armchairs D900.16 and D900.17 are also available with a round aluminum swivel base.
<b>Tellerfuss für Sessel</b>	360° drehbarer Tellerfuss aus Aluminiumguss, hochglanzpoliert. Ausführung mit Kunststoffgleitern. Für Parkett und Steinboden auf Wunsch mit Filzeinlage möglich. Bitte unbedingt bei der Bestellung angeben da ein nachträgliches Umrüsten nicht möglich ist.	<b>Round swivel base for armchairs</b>	Round cast aluminum swivel base, 360° rotatable, highly polished, with gliders. Felt insert for parquet and stone floors available on request. Please specify on the order, as subsequent changes are not possible.
<b>Verbindungsbeslag</b>	Verbindungsbeschläge für die Sofas werden mitgeliefert oder auf Wunsch montiert. <b>Bitte bei Bestellung unbedingt angeben.</b>	<b>Connecting fixtures</b>	Connecting fixtures for the sofas are delivered with the order or fitted on request. <b>Please specify in your order.</b>

<b>Châssis</b>	Châssis d'assise et de dossier en bois stratifié et hêtre massif. Chevillé et collé.	<b>Frame</b>	Zitting- en ruggeraamte van multiplexplaten en massief beukenhout. Geplugd en vastgelijmd.
<b>Suspension</b>	Suspension en mousse de polyéther résistante. <b>A</b> Mousse de polyéther, RG 43 / 2,8, <b>B</b> Mousse de polyéther, RG 50 / 2,0	<b>Vering</b>	Vering van zeer draagkrachtig polyetherschuim <b>A</b> Polyetherschuim, RG 43 / 2,8, <b>B</b> Polyetherschuim, RG 50 / 2,0
<b>Coussins d'assise</b>	Rembourrage à quatre couches <b>A</b> Mousse de polyéther, RG 43 / 5,0 <b>B</b> Mousse à froid, RG 42 / 4,5 <b>C</b> Mousse de polyéther, RG 40 / 1,4 <b>D</b> Revêtement fibres de rembourrage 345 g /qm	<b>Zitkussens</b>	Vier-laags vering <b>A</b> Polyetherschuim, RG 43 / 5,0 <b>B</b> Koud schuim, RG 42 / 4,5 <b>C</b> Polyetherschuim, RG 40 / 1,4 <b>D</b> Vormelastische vliesbedekking 345 g/m <sup>2</sup>
<b>Dossier</b>	Mousse spéciale Dreipunkt RG 33 / 15,0.	<b>Rugromp</b>	Dreipunkt speciaal schuim RG 33 / 15,0
<b>Coussins de dossier</b>	Coussins capitonnés amovibles type duvet. Garnissage Dreipunkt Selecta RG 80 (80%) et fibres polyester de rembourrage élastiques (20%). Pour l'entretien nous recommandons de secouer régulièrement les coussins du dossier un par un.	<b>Rugkussens</b>	Losse kamerkussens met donskarakter, gevuld met een mengsel van Dreipunkt Selecta RG 80 (80%) en vormelastische vliesvezels (20%). Voor een maximaal zitcomfort raden u aan de verschillende rugkussens regelmatig op te schudden.
<b>Finition pieds</b>	Pieds en métal ou en bois Pour le fauteuil D 900.16 und D 900.17 également disponible avec un base ronde pivotante en aluminium.	<b>Poten</b>	Metalen of houten voet Optioneel fauteuil D900.16 en D900.17 ook met aluminium schotelvoet.
<b>Pied en disque pour fauteuil</b>	Pied en disque pivotant à 360° en aluminium fondu, brillant Finition avec patins en matière synthétique. Disponible sur demande avec doublure en feutre pour les parquets et les sols dallés. A préciser impérativement à la commande, une modification ultérieure n'étant pas possible.	<b>Schotelvoet voor fauteuil</b>	360° draaibare schotelvoet van gietaluminium, glanzend gepolijst. Uitvoering met kunststof glijders. Voor parket en stenen vloeren op aanvraag met viltlaag mogelijk. Gelieve dit bij de bestelling duidelijk te specificeren. Achteraf ombouwen is niet mogelijk.
<b>Ferrure d'assemblage</b>	Les ferrures d'assemblage pour les canapés peuvent être livrées ou montées sur demande. <b>A préciser impérativement à la commande.</b>	<b>Verbindingsbeslag</b>	Verbindingsbeslag voor de sofa's wordt meegeleverd of op aanvraag gemonteerd. <b>Gelieve dit bij de bestelling duidelijk te specificeren.</b>

