

# D800 LOOP

Produktumfang / Product range / Gamme des produits / Productomvang

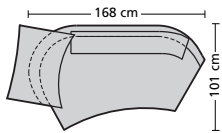

800.21 L

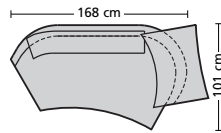

800.21 R

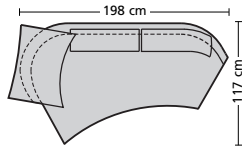

800.29 L

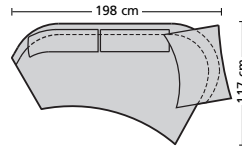

800.29 R

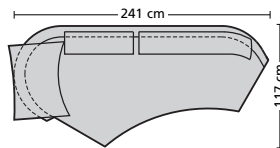

800.31 L

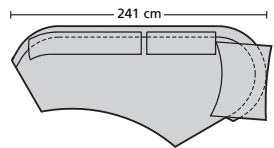

800.31 R

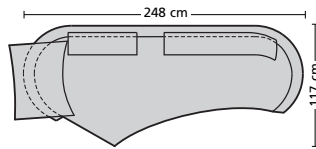

800.32 L

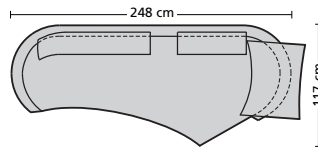

800.32 R

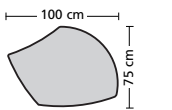

800.63

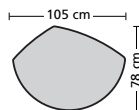

800.64

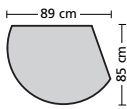

800.648 L  
Tischhocker

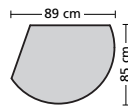

800.648 R  
Tischhocker

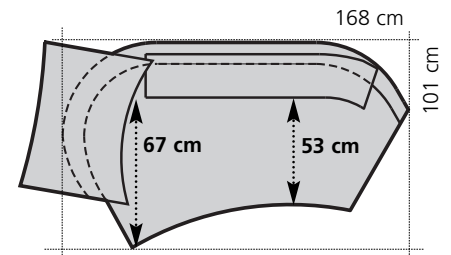

800.21 L

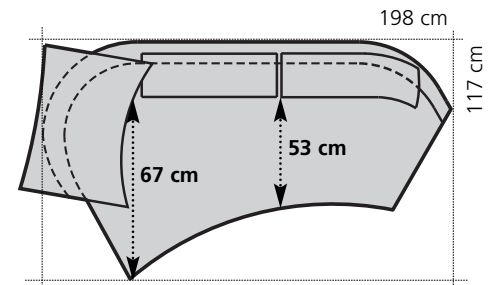

800.29 L

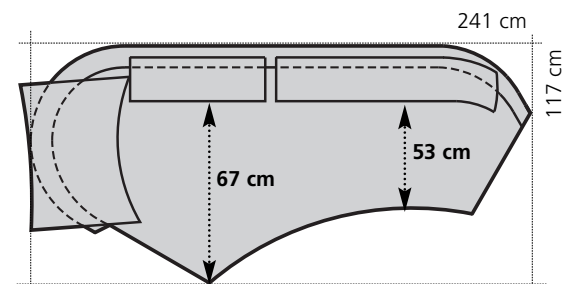

800.31 L

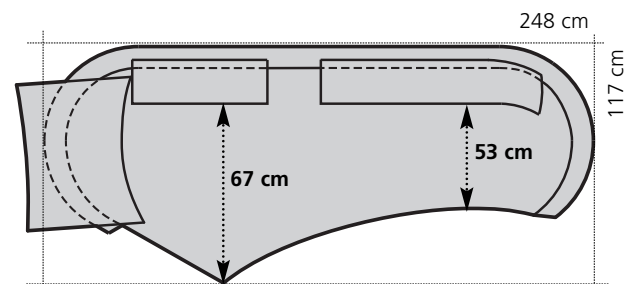

800.32 L

## Hinweise zu den Kombinationsmöglichkeiten

**Eine 90°- Eklösung ist nur in Verbindung mit dem Anreihsofa 2 1/2-sitzig 800.31 rechts oder links möglich.**

Notes on possible combinations

A 90° corner solution is only possible with the 2 1/2-seater 800.31 add-on sofa (right or left)

Remarques sur les possibilités de composition

une composition à angle droit (90°) n'est possible qu'en liaison avec le canapé juxtaposable à 2 1/2-places 800.31 à droite ou à gauche.

Aanwijzingen voor de combinatiemogelijkheden

een 90°- hoekoplossing is alleen mogelijk in combinatie met de aanbouwsofa 2 1/2-zits 800.31 rechts of links.

# D800 LOOP

## Kombinationsbeispiele / Arrangements

Exemples de composition / Combinatie voorbeelden

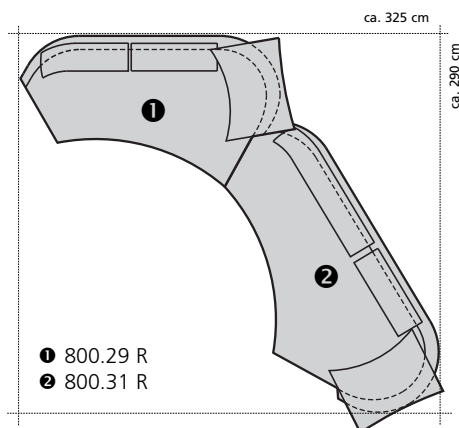
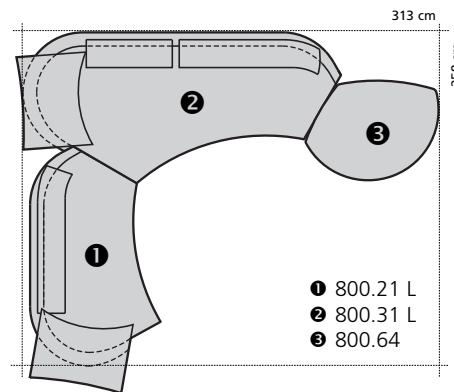
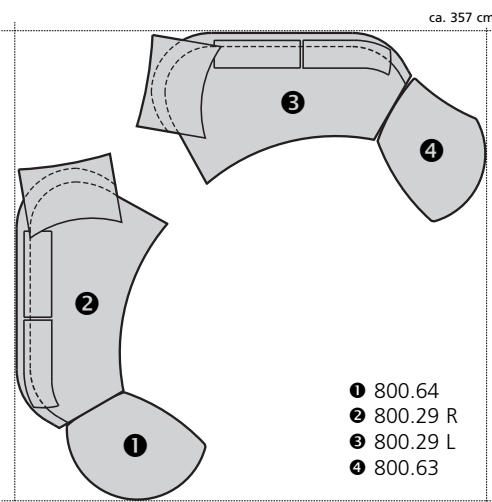
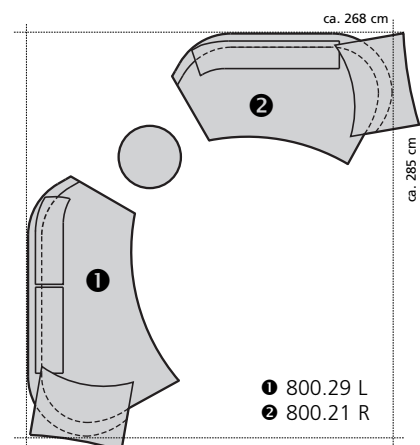
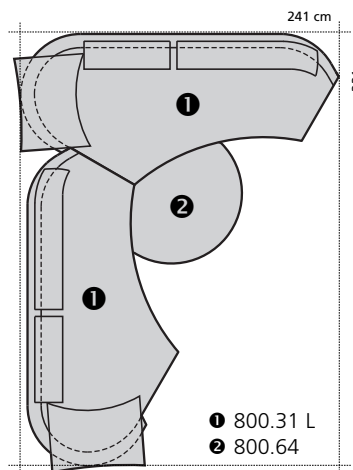
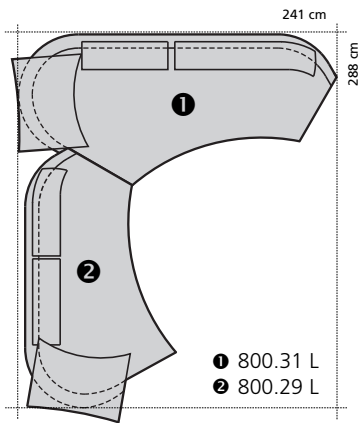







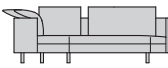
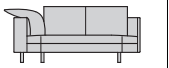
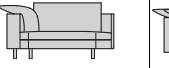
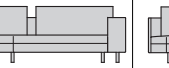
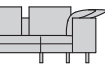
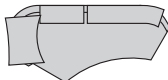
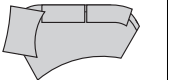
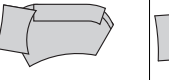
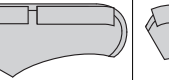
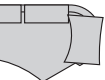

### Berechnung des Stellmaßes bei Kombinationen mit Sofa D800.31 Tiefe Modell D800.31 + Breite D800.29 oder D800.21 -27cm



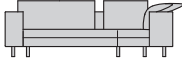



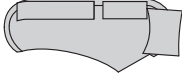

Calculating the width dimension when combined with sofa D800.31  
Depth of sofa D800.31 + width of sofa D800.29 or D800.21 -27cm.

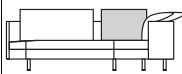
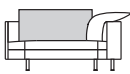
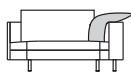

Calcul des dimensions d'implantation pour les compositions avec modèle D800.31  
Profondeur modèle D800.31 + largeur D800.29 ou D800.21 -27cm

Berekening van de stelmaat bij combinatie met model D800.31  
Diepte model D800.31 + breedte D800.29 of D800.21 -27 cm

					
					
	Anreihsofa links 2 1/2-sitzig	Anreihsofa links 2 1/2-sitzig	Anreihsofa links 2-sitzig	Sofa links 2 1/2-sitzig	Anreihsofa rechts 2 1/2-sitzig
<b>Breite</b> / Width / Largeur / Breedte	241 cm	198 cm	168 cm	248 cm	241 cm
<b>Tiefe</b> / Depth / Profondeur / Diepte	117 cm	117 cm	101 cm	117 cm	117 cm
<b>Höhe</b> / Height / Hauteur / Hoogte	96 cm	96 cm	96 cm	96 cm	96 cm
<b>Sitzhöhe</b> / Seat height / Hauteur de siège / Zithoogte	42 cm	42 cm	42 cm	42 cm	42 cm
<b>Sitztiefe</b> / Seat depth / Profondeur siège / Zitdiepte	53 - 67 cm	53 - 67 cm	53 - 67 cm	53 - 67 cm	53 - 67 cm
<b>Bestell-Nr.</b> / Order no. / N° de commande / Ordernu.	<b>D800.31 L</b>	<b>D800.29 L</b>	<b>D800.21 L</b>	<b>D800.32 L</b>	<b>D800.31 R</b>
<b>Stoffgruppe</b>	12 <b>2775</b>	13 <b>2475</b>	14 <b>2175</b>	15 <b>3125</b>	16 <b>2775</b>
Fabric category	13 <b>2875</b>	14 <b>2575</b>	15 <b>2250</b>	16 <b>3175</b>	17 <b>2875</b>
Catégorie de tissu	14 <b>2975</b>	15 <b>2625</b>	16 <b>2275</b>	17 <b>3250</b>	18 <b>2975</b>
Stofgroep	15 <b>3075</b>	16 <b>2675</b>	17 <b>2295</b>	18 <b>3325</b>	19 <b>3075</b>
	16 <b>3125</b>	17 <b>2725</b>	18 <b>2325</b>	19 <b>3375</b>	20 <b>3125</b>
	17 <b>3175</b>	18 <b>2795</b>	19 <b>2395</b>	20 <b>3475</b>	21 <b>3175</b>
	18 <b>3275</b>	19 <b>2875</b>	20 <b>2475</b>	21 <b>3575</b>	22 <b>3275</b>
	19 <b>3375</b>	20 <b>2975</b>	21 <b>2575</b>	22 <b>3775</b>	23 <b>3375</b>
	20 <b>3475</b>	21 <b>3075</b>	22 <b>2675</b>	23 <b>3875</b>	24 <b>3475</b>
<b>Avantgarde</b>	<b>3275</b>	<b>2875</b>	<b>2475</b>	<b>3575</b>	<b>3275</b>
<b>Ledergruppe</b>	Derby <b>3975</b>	Touch <b>3375</b>	Premium <b>2975</b>	Nature <b>4475</b>	Imperial <b>3975</b>
Leather category	Touch <b>4175</b>	Premium <b>3575</b>	Nature <b>3075</b>	Imperial <b>4675</b>	Derby <b>4175</b>
Catégorie de cuir	Premium <b>4275</b>	Nature <b>3675</b>	Imperial <b>3175</b>	Derby <b>4775</b>	Touch <b>4275</b>
Leergroep	Nature <b>4675</b>	Imperial <b>3975</b>	Derby <b>3575</b>	Touch <b>5275</b>	Premium <b>4675</b>
	Imperial <b>4975</b>	Derby <b>4375</b>	Touch <b>3975</b>	Premium <b>5775</b>	Nature <b>4975</b>
<b>Preis bei Stoffzugabe</b>	<b>2675</b>	<b>2375</b>	<b>2075</b>	<b>3025</b>	<b>2675</b>
Price in customer's own fabric					
Prix sans matériau de recouvrement					
Prijs bij eigen stof					
<b>Stoffbedarf, ohne Rapport</b>					
Fabric requirement, without pattern					
Métrage de tissu nécessaire, sans raccord					
Benodigde bekledingsstof zonder rapport					
<b>140 cm breit</b> / wide / large / breedte	8,50 m	7,20 m	6,30 m	9,80 m	8,50 m
<b>130 cm breit</b> / wide / large / breedte	9,20 m	7,80 m	6,80 m	10,90 m	9,20 m

					
					
	Anreihsofa rechts 2 1/2-sitzig	Anreihsofa rechts 2-sitzig	Sofa rechts 2 1/2-sitzig	Hocker	Hocker
<b>Breite</b> / Width / Largeur / Breedte	198 cm	168 cm	248 cm	105 cm	100 cm
<b>Tiefe</b> / Depth / Profondeur / Diepte	117 cm	101 cm	117 cm	78 cm	75 cm
<b>Höhe</b> / Height / Hauteur / Hoogte	96 cm	96 cm	96 cm	42 cm	42 cm
<b>Sitzhöhe</b> / Seat height / Hauteur de siège / Zithoogte	42 cm	42 cm	42 cm	-	-
<b>Sitztiefe</b> / Seat depth / Profondeur siège / Zitdiepte	53 - 67 cm	53 - 67 cm	53 - 67 cm	-	-
<b>Bestell-Nr.</b> / Order no. / N° de commande / Ordernu.	<b>D800.29 R</b>	<b>D800.21 R</b>	<b>D800.32 R</b>	<b>D800.64</b>	<b>D800.63</b>
<b>Stoffgruppe</b>	12 <b>2475</b>	13 <b>2175</b>	14 <b>3125</b>	15 <b>650</b>	16 <b>695</b>
Fabric category	13 <b>2575</b>	14 <b>2250</b>	15 <b>3175</b>	16 <b>675</b>	17 <b>725</b>
Catégorie de tissu	14 <b>2625</b>	15 <b>2275</b>	16 <b>3250</b>	17 <b>695</b>	18 <b>745</b>
Stofgroep	15 <b>2675</b>	16 <b>2295</b>	17 <b>3325</b>	18 <b>725</b>	19 <b>775</b>
	16 <b>2725</b>	17 <b>2325</b>	18 <b>3375</b>	19 <b>750</b>	20 <b>795</b>
	17 <b>2795</b>	18 <b>2395</b>	19 <b>3475</b>	20 <b>775</b>	<b>825</b>
	18 <b>2875</b>	19 <b>2475</b>	20 <b>3575</b>	<b>795</b>	<b>845</b>
	19 <b>2975</b>	20 <b>2575</b>	<b>3775</b>	<b>850</b>	<b>895</b>
	20 <b>3075</b>	<b>2675</b>	<b>3875</b>	<b>875</b>	<b>925</b>
<b>Avantgarde</b>	<b>2875</b>	<b>2475</b>	<b>3575</b>	<b>795</b>	<b>850</b>
<b>Ledergruppe</b>	Derby <b>3475</b>	Touch <b>2975</b>	Premium <b>4475</b>	Nature <b>975</b>	Imperial <b>1050</b>
Leather category	Touch <b>3575</b>	Premium <b>3075</b>	Nature <b>4675</b>	Imperial <b>995</b>	<b>1075</b>
Catégorie de cuir	Premium <b>3675</b>	Nature <b>3175</b>	Imperial <b>4775</b>	<b>1075</b>	<b>1175</b>
Leergroep	Nature <b>3975</b>	Imperial <b>3575</b>	<b>5275</b>	<b>1175</b>	<b>1275</b>
	Imperial <b>4375</b>	<b>3975</b>	<b>5775</b>	<b>1275</b>	<b>1375</b>
<b>Preis bei Stoffzugabe</b>	<b>2375</b>	<b>2075</b>	<b>3025</b>	<b>625</b>	<b>674</b>
Price in customer's own fabric					
Prix sans matériau de recouvrement					
Prijs bij eigen stof					
<b>Stoffbedarf, ohne Rapport</b>					
Fabric requirement, without pattern					
Métrage de tissu nécessaire, sans raccord					
Benodigde bekledingsstof zonder rapport					
<b>140 cm breit</b> / wide / large / breedte	7,20 m	6,30 m	9,80 m	2,00 m	1,90 m
<b>130 cm breit</b> / wide / large / breedte	7,80 m	6,80 m	10,90 m	2,20 m	2,10 m

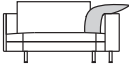
<b>Rückenkissen können zusätzlich einzeln bestellt werden.</b> The back cushions can be ordered separately. Les coussins de siège peuvent à commander séparément. De rugkussens kunnen extra besteld worden.						
						
	Tischhocker links	Tischhocker rechts	Rückenkissen	Rückenkissen	Eckkissen	
<b>Breite</b> / Width / Largeur / Breedte	89 cm	89 cm	65 x 45 x 12 cm	105 x 45 x 12 cm	70 x 70 x 12 cm	
<b>Tiefe</b> / Depth / Profondeur / Diepte	85 cm	85 cm	-	-	-	
<b>Höhe</b> / Height / Hauteur / Hoogte	42 / 31 cm	42 / 31 cm	-	-	-	
<b>Sitzhöhe</b> / Seat height / Hauteur de siège / Zithoogte	-	-	-	-	-	
<b>Sitztiefe</b> / Seat depth / Profondeur siège / Zitdiepte	-	-	-	-	-	
<b>Bestell-Nr.</b> / Order no. / N° de commande / Ordernu.	<b>D800.648 L</b>	<b>D800.648 R</b>	<b>D800.930</b>	<b>D800.931</b>	<b>D800.932</b>	
<b>Stoffgruppe</b>	12	<b>925</b>	<b>925</b>	<b>125</b>	<b>165</b>	<b>195</b>
Fabric category	13	<b>945</b>	<b>945</b>	<b>135</b>	<b>175</b>	<b>215</b>
Catégorie de tissu	14	<b>955</b>	<b>955</b>	<b>145</b>	<b>185</b>	<b>225</b>
Stofgroep	15	<b>965</b>	<b>965</b>	<b>155</b>	<b>195</b>	<b>235</b>
	16	<b>965</b>	<b>965</b>	<b>160</b>	<b>200</b>	<b>245</b>
	17	<b>975</b>	<b>975</b>	<b>165</b>	<b>205</b>	<b>255</b>
	18	<b>1000</b>	<b>1000</b>	<b>175</b>	<b>225</b>	<b>275</b>
	19	<b>1045</b>	<b>1045</b>	<b>185</b>	<b>235</b>	<b>285</b>
	20	<b>1075</b>	<b>1075</b>	<b>195</b>	<b>245</b>	<b>295</b>
<b>Avantgarde</b>		<b>1000</b>	<b>1000</b>	<b>175</b>	<b>225</b>	<b>275</b>
<b>Ledergruppe</b>	Derby	<b>1075</b>	<b>1075</b>	<b>225</b>	<b>275</b>	<b>325</b>
Leather category	Touch	<b>1100</b>	<b>1100</b>	<b>235</b>	<b>295</b>	<b>350</b>
Catégorie de cuir	Premium	<b>1125</b>	<b>1125</b>	<b>255</b>	<b>325</b>	<b>375</b>
Leergroep	Nature	<b>1225</b>	<b>1225</b>	<b>295</b>	<b>350</b>	<b>395</b>
	Imperial	<b>1325</b>	<b>1325</b>	<b>325</b>	<b>375</b>	<b>425</b>
<b>Preis bei Stoffzugabe</b>		<b>905</b>	<b>905</b>	<b>120</b>	<b>160</b>	<b>190</b>
Price in customer's own fabric						
Prix sans matériau de recouvrement						
Prijs bij eigen stof						
<b>Stoffbedarf, ohne Rapport</b>						
Fabric requirement, without pattern						
Métrage de tissu nécessaire, sans raccord						
Benodigde bekledingsstof zonder rapport						
<b>140 cm breit</b> / wide / large / breedte		2,00 m	2,00 m	1,00 m	1,40 m	1,80 m
<b>130 cm breit</b> / wide / large / breedte		2,10 m	2,10 m	1,10 m	1,50 m	1,95 m

<p><b>Rückenkissen können zusätzlich einzeln bestellt werden.</b></p> <p>The back cushions can be ordered separately.</p> <p>Les coussins de siège peuvent à commander séparément.</p> <p>De rugkussens kunnen extra besteld worden.</p>					
					
	Eckkissen				
<b>Breite</b> / Width / Largeur / Breedte	70 x 60 x 12 cm				
<b>Tiefe</b> / Depth / Profondeur / Diepte	-				
<b>Höhe</b> / Height / Hauteur / Hoogte	-				
<b>Sitzhöhe</b> / Seat height / Hauteur de siège / Zithoogte	-				
<b>Sitztiefe</b> / Seat depth / Profondeur siège / Zitdiepte	-				
<b>Bestell-Nr.</b> / Order no. / N° de commande / Ordernu.	<b>D800.933</b>				
<b>Stoffgruppe</b>	12	<b>165</b>			
Fabric category	13	<b>185</b>			
Catégorie de tissu	14	<b>195</b>			
Stofgroep	15	<b>205</b>			
	16	<b>215</b>			
	17	<b>225</b>			
	18	<b>245</b>			
	19	<b>255</b>			
	20	<b>265</b>			
<b>Avantgarde</b>		<b>245</b>			
<b>Ledergruppe</b>	Derby	<b>295</b>			
Leather category	Touch	<b>325</b>			
Catégorie de cuir	Premium	<b>345</b>			
Leergroep	Nature	<b>365</b>			
	Imperial	<b>395</b>			
<b>Preis bei Stoffzugabe</b>		<b>160</b>			
Price in customer's own fabric					
Prix sans matériau de recouvrement					
Prijs bij eigen stof					
<b>Stoffbedarf, ohne Rapport</b>					
Fabric requirement, without pattern					
Métrage de tissu nécessaire, sans raccord					
Benodigde bekledingsstof zonder rapport					
<b>140 cm breit</b> / wide / large / breedte		1,10 m			
<b>130 cm breit</b> / wide / large / breedte		1,80 m			

# D800 LOOP

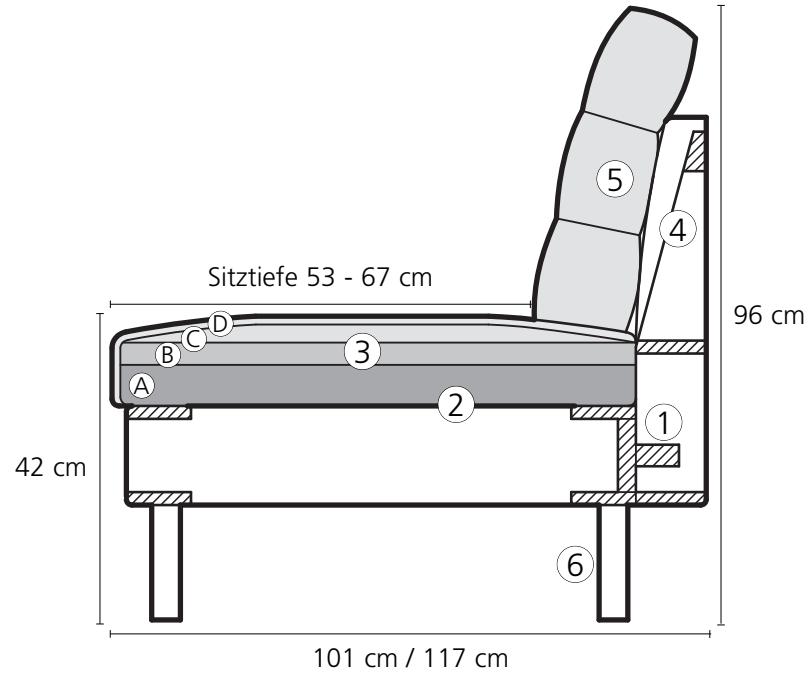

<b>Gestell</b>	Rahmenkonstruktion aus Schichtholzplatten und massiver Buche. Gedübelt und verleimt.	<b>Frame</b>	Frame construction made of plywood panels and solid beech. Doweled and glued.
<b>Unterfederung</b>	Dauerelastisches Federungssystem	<b>Spring base</b>	Permanent elastic spring system
<b>Sitzkissen</b>	Vierschichtiger Polsteraufbau <b>A</b> Polyätherschaum, RG 43 / 5,0 <b>B</b> Kaltschaum, RG 42 / 4,5 <b>C</b> Polyätherschaum, RG 40 / 1,4 <b>D</b> Vliesabdeckung 345 g/m <sup>2</sup>	<b>Seat cushions</b>	Four-layered cushion structure <b>A</b> Polyether foam, density 43 / 5.0 <b>B</b> Cold foam, density 42 / 4.5 <b>C</b> Polyether foam, density 40 / 1.4 <b>D</b> Polyester padding 345 g/m <sup>2</sup>
<b>Rückenkorpus</b>	Spezialpolyäther RG 35 / 4,0 mit Seitenverstärkung aus Spezialpolyäther RG 75 / 13,0	<b>Back body</b>	Special polyether foam density 35 / 4.0 with lateral reinforcement made of special polyether foam density 75 / 13.0.
<b>Rückenkissen</b>	Lose Kammerkissen mit Daunencharakter. Füllung Dreipunkt Selecta RG 80 (80%) und dauerelastischen Vliesfasern (20%). Zur Pflege empfehlen wir ein regelmässiges Aufschütteln der einzelnen Rückenkissen.	<b>Back cushions</b>	Loose chamber cushions with a downy character. Filled with Dreipunkt Selecta density 80 (80%) and permanent elastic polyester fibers (20%) The single back cushions should be plumped up on a regular basis.
<b>Füsse</b>	Metall- oder Holzfuss	<b>Legs</b>	Metal or wooden legs
<b>Verbindungs- beschlag</b>	Verbindungsbeschläge für die Sofas werden mitgeliefert oder auf Wunsch montiert. <b>Bitte bei Bestellung unbedingt angeben.</b>	<b>Connecting fixtures</b>	Connecting fixtures are delivered with the order or fitted on request. <b>Please specify in your order.</b>
<hr/>			
<b>Châssis</b>	Châssis en plaques de bois stratifié et hêtre massif. Chevillé et collé.	<b>Frame</b>	Geraamte van multiplexplaten en massief beukenhout. Geplugd en vastgelijmd.
<b>Suspension</b>	Système de suspension élastique.	<b>Vering</b>	Permanent elastisch veringsysteem
<b>Coussins d'assise</b>	Rembourrage à quatre couches <b>A</b> Mousse de polyéther, RG 43 / 5,0 <b>B</b> Mousse à froid, RG 42 / 4,5 <b>C</b> Mousse de polyéther, RG 40 / 1,4 <b>D</b> Revêtement fibres de rembourrage 345 g/qm	<b>Zitkussens</b>	Vier-laags vering <b>A</b> Polyetherschium, RG 43 / 5,0 <b>B</b> Koud schuim, RG 42 / 4,5 <b>C</b> Polyetherschium, RG 40 / 1,4 <b>D</b> Vliesbedekking 345 g/m <sup>2</sup>
<b>Dossier</b>	Polyéther spécial RG 35 / 4,0 avec parties latérales renforcées en polyéther spécial RG 75 / 13,0	<b>Rugromp</b>	Speciaal polyether RG 35 / 4,0 met zijversterking uit speciaal polyether RG 75 / 13,0.
<b>Coussins de dossier</b>	Coussins capitonnés amovibles type duvet. Garnissage Dreipunkt Selecta RG 80 (80%) et fibres polyester de rembourrage élastiques (20%). Pour l'entretien, nous recommandons de secouer régulièrement les coussins de dossier un par un.	<b>Rugkussens</b>	Losse kamerkussens met donskarakter, gevuld met een mengsel van Dreipunkt Selecta RG 80 (80%) en vormelastische vliesbekleding (20%). Voor een maximaal zitcomfort raden u aan de verschillende rugkussens regelmatig op te schudden.
<b>Pieds</b>	Pieds en métal ou en bois	<b>Poten</b>	Metalen of houten voet
<b>Ferrure d'assemblage</b>	Les ferrures d'assemblage pour les canapés peuvent être livrées ou montées sur demande. <b>A préciser impérativement à la commande.</b>	<b>Verbindings- beslag</b>	Verbindingsbeslag voor de sofa's wordt meegeleverd of op aanvraag gemonteerd. <b>Gelieve dit bij de bestelling duidelijk te specificeren.</b>

## Füsse / Legs / Pieds / Voeten



**D 2**  
Metallfuss rund,  
**hochglanz verchromt**  
Ø 30 mm,  
160 mm hoch

Metal leg, round,  
**highly polished chromium-plated**  
Ø 30 mm,  
height 160 mm

**D 2**  
Pied métallique rond,  
**chromé brillant**  
Ø 30 mm,  
160 mm de haut

Ronde metalen voet,  
**glanzend verchromd**  
Ø 30 mm,  
160 mm hoog



**D 2**  
Metallfuss rund,  
**matt verchromt**  
Ø 30 mm,  
160 mm hoch

Metal leg, round,  
**mat chromium-plated**  
Ø 30 mm,  
height 160 mm

**D 2**  
Pied métallique rond,  
**chromé mat**  
Ø 30 mm,  
160 mm de haut

Ronde metalen voet,  
**mat verchromd**  
Ø 30 mm,  
160 mm hoog

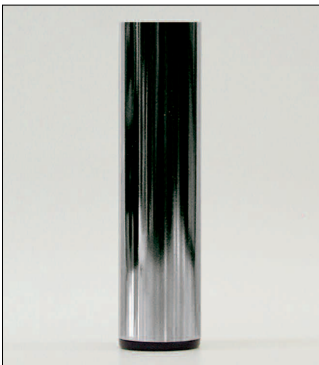

**D 4**  
Metallfuss rund,  
**hochglanz verchromt**  
Ø 40 mm,  
160 mm hoch

Metal leg, round,  
**highly polished chromium-plated**  
Ø 40 mm,  
height 160 mm

**D 4**  
Pied métallique rond,  
**chromé brillant**  
Ø 40 mm,  
160 mm de haut

Ronde metalen voet,  
**glanzend verchromd**  
Ø 40 mm,  
160 mm hoog



**D 4**  
Metallfuss rund,  
**matt verchromt**  
Ø 40 mm,  
160 mm hoch

Metal leg, round,  
**mat chromium-plated**  
Ø 40 mm,  
height 160 mm

**D 4**  
Pied métallique rond,  
**chromé mat**  
Ø 40 mm,  
160 mm de haut

Ronde metalen voet,  
**mat verchromd**  
Ø 40 mm,  
160 mm hoog



**D 47**  
Fuss Buche natur,  
Ø 35 mm,  
160 mm hoch,  
Sonderlackierung gegen Aufpreis.

Round beech foot,  
Ø 35 mm,  
160 mm high,  
Extra charge for special colours see  
special designs price list.

**D 47**  
Pied en hêtre naturel.  
Ø 35 mm,  
160 mm de haut  
Couleurs spéciales moyennant  
supplément.

Houten voet, blank beuken,  
Ø 35 mm,  
160 mm hoog  
Speciale kleuren tegen meerprijs.