

D740 COVER

Produktumfang / Product range / Gamme des produits / productomvang

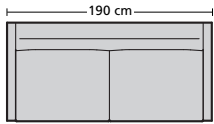

P740.26

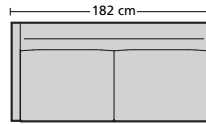

P740.46 L

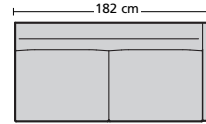

P740.46 R

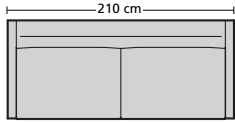

P740.27

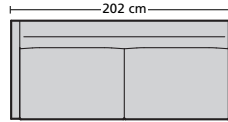

P740.47 L

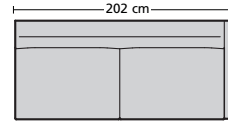

P740.47 R

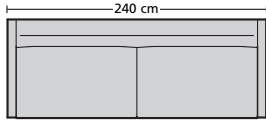

P740.28

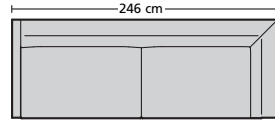

P740.72 L

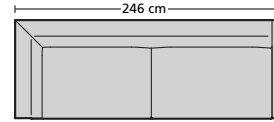

P740.72 R

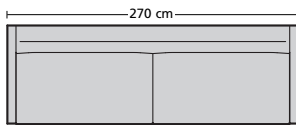

P740.29

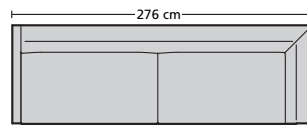

P740.77 L

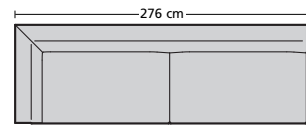

P740.77 R

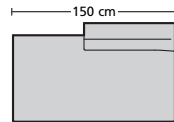

P740.67 L

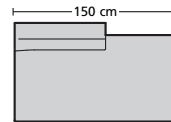

P740.67 R

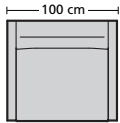

P740.12

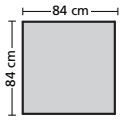







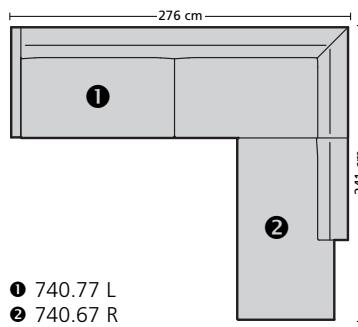
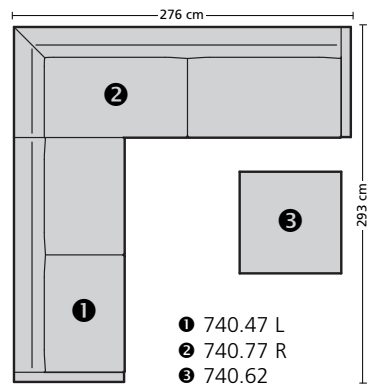
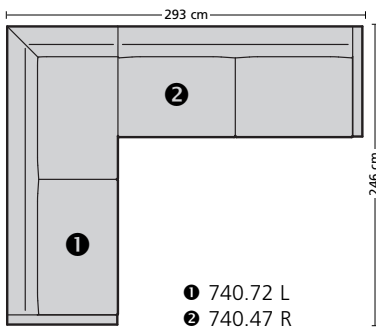
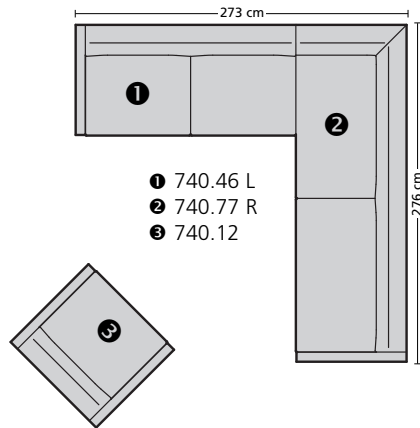
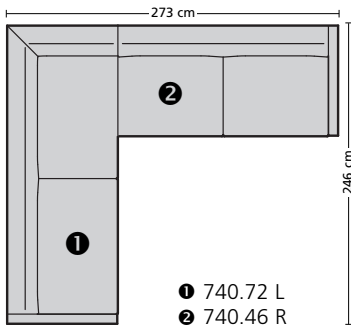



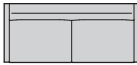





P740.62 Hocker

D740 COVER

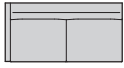
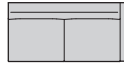
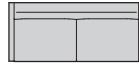
Kombinationsbeispiele / Arrangements
Exemples de composition / Combinatie voorbeelden

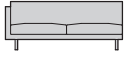
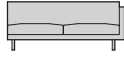

					
					
	Sessel	Sofa 2 2-sitzig	Sofa 2,5 2 1/2-sitzig	Sofa 2,5 2 1/2-sitzig	Sofa 4 4-sitzig
Breite / Width / Largeur / Breedte	100 cm	190 cm	210 cm	240 cm	270 cm
Tiefe / Depth / Profondeur / Diepte	91 cm	91 cm	91 cm	91 cm	91 cm
Höhe / Height / Hauteur / Hoogte	77 cm	77 cm	77 cm	77 cm	77 cm
Sitzhöhe / Seat height / Hauteur de siège / Zithoogte	44 cm	44 cm	44 cm	44 cm	44 cm
Sitztiefe / Seat depth / Profondeur siège / Zitdiepte	65 cm	65 cm	65 cm	65 cm	65 cm
Bestell-Nr. / Order no. / N° de commande / Ordernu.	740.12	740.26	740.27	740.28	740.29
Stoffgruppe	13	1225	1925	2225	2525
Fabric category	14	1250	1950	2250	2750
Catégorie de tissu	15	1275	1975	2275	2775
Stofgroep	16	1325	2075	2350	2850
	17	1375	2175	2450	2950
	18	1395	2275	2550	3075
	19	1475	2375	2650	3175
	20	1575	2475	2750	3275
Avantgarde		1350	2250	2450	2750
Ledergruppe	Derby	1575	2675	2975	3375
Leather category	Touch	1775	2875	3175	3775
Catégorie de cuir	Premium	1875	2975	3275	3775
Leergroep	Nature	1975	3275	3575	4075
	Imperial	2275	3675	3975	4775
Preis bei Stoffzugabe		1175	1875	2175	2450
Price in customer's own fabric					
Prix sans matériau de recouvrement					
Prijs bij eigen stof					
Stoffbedarf, ohne Rapport					
Fabric requirement, without pattern					
Métrage de tissu nécessaire, sans raccord					
Benodigde bekledingsstof zonder rapport					
140 cm breit / wide / large / breedte	4,50 m	7,10 m	7,60 m	8,30 m	8,90 m
130 cm breit / wide / large / breedte	4,90 m	7,80 m	8,40 m	9,20 m	9,80 m

						
						
		Anreihsofa 2 2-sitzig	Anreihsofa 2 2-sitzig	Anreihsofa 2,5 2 1/2-sitzig	Anreihsofa 2,5 2 1/2-sitzig	Anreihecksofa 2 1/2-sitzig
Breite / Width / Largeur / Breedte		182 cm	182 cm	202 cm	202 cm	246 cm
Tiefe / Depth / Profondeur / Diepte		91 cm	91 cm	91 cm	91 cm	91 cm
Höhe / Height / Hauteur / Hoogte		77 cm	77 cm	77 cm	77 cm	77 cm
Sitzhöhe / Seat height / Hauteur de siège / Zithoogte		44 cm	44 cm	44 cm	44 cm	44 cm
Sitztiefe / Seat depth / Profondeur siège / Zitdiepte		65 cm	65 cm	65 cm	65 cm	65 cm
Bestell-Nr. / Order no. / N° de commande / Ordernu.		740.46 L	740.46 R	740.47 L	740.47 R	740.72 L
Stoffgruppe	13	1925	1925	2125	2125	2650
Fabric category	14	1950	1950	2150	2150	2675
Catégorie de tissu	15	1975	1975	2175	2175	2775
Stofgroep	16	2025	2025	2250	2250	2875
	17	2075	2075	2295	2295	2975
	18	2175	2175	2375	2375	3075
	19	2275	2275	2475	2475	3175
	20	2375	2375	2575	2575	3275
Avantgarde		2075	2075	2275	2275	2875
Ledergruppe	Derby	2575	2575	2775	2775	3475
Leather category	Touch	2775	2775	2975	2975	3675
Catégorie de cuir	Premium	2975	2975	3175	3175	3875
Leergroep	Nature	3175	3175	3375	3375	4075
	Imperial	3375	3375	3675	3675	4575
Preis bei Stoffzugabe		1875	1875	2075	2075	2575
Price in customer's own fabric						
Prix sans matériau de recouvrement						
Prijs bij eigen stof						
Stoffbedarf, ohne Rapport						
Fabric requirement, without pattern						
Métrage de tissu nécessaire, sans raccord						
Benodigde bekledingsstof zonder rapport						
140 cm breit / wide / large / breedte		6,30 m	6,30 m	6,80 m	6,80 m	8,20 m
130 cm breit / wide / large / breedte		6,90 m	6,90 m	7,50 m	7,50 m	9,10 m

D740 COVER

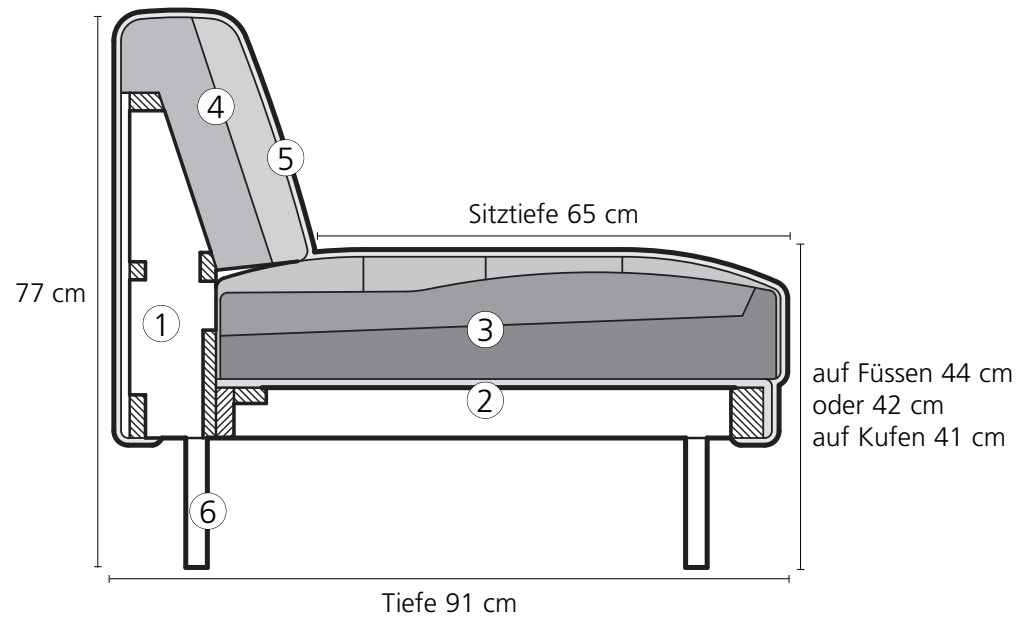

D740 COVER

Gestell	Sitz- und Rückenkonstruktion Buche massiv und Schichtholz, gedübelt und verleimt.	Frame	Seat and back construction solid beech and plywood, doweled and glued.
Unterfederung	Dauerelastisches Federungssystem.	Spring base	Permanent elastic spring system.
Sitzkissen	Mehrschichtiger Kissen Aufbau aus Kaltschaum RG 45, SH 4.0 und viscoelastischem Schaum SH 1.4. Abdeckung in Kammerkissenverarbeitung. Füllung in den einzelnen Kammern: 90% Gänsefeder, 10% Entenfeder.	Seat cushions	Multi-layered cushion structure consisting of cold foam density 45 / CLD 4,0 and viscoelastic foam CLD 1,4. Padding with a chambered construction. Filling in the single chambers: 90% goose feather, 10% duck feather.
Rücken	Zweischichtiger Vollpolster Aufbau aus Kaltschaum RG 32, SH 2.5 und RG 27, SH 1.6 vorn.	Back cushions	Two-layered fully upholstered cushion structure made of cold foam density 32 / CLD 2,5 and density 27 / CLD 1,6 in front.
Seitenteil	Armteilaufgabe aus Polyätherschaum RG 75, SH 13.0	Side element	Armrest padding made of polyether foam density 75 / CLD 13,0.
Unterbezug	Unterbezug aus kaschierem Schaumstoff 2,7 mm stark mit Gewebearmierung an der Innenseite.	Inner cover	Inner cover made of laminated foam 2,7 mm thick with reinforcement fabric on the inside.
Fussausführungen	Stahlfuss hochglanz verchromt, Durchmesser 30 mm, Höhe 180 mm Sitzhöhe 44 cm oder Höhe 160 mm Sitzhöhe 42 cm oder Kufen Flachstahl, hochglanz verchromt, 50 mm breit, 150 mm hoch Sitzhöhe 41 cm	Legs	Steel legs, highly polished chromium-plated, diameter 30 mm, 180 mm high seat height 44 cm or 160 mm high seat height 42 cm or flat steel skids, highly polished chromium-plated, 50 mm wide, 150 mm high seat height 41 cm .
Besondere Merkmale	Wechselbezüge bei Korpus und Kissen.	Special features	Body and cushions with removable covers.

Support	Structure d'assise et de dossier en hêtre massif et bois stratifié, chevillé et collé.	Frame	Zitting- en rugconstructie massief beuken en gelaagd hout, gepend en gelijmd.
Suspension	Système de suspension à élasticité permanente.	Vering	Permanent elastisch veringssysteem.
Coussins d'assise	Rembouillage à plusieurs couches composé de mousse à froid RG 45, SH 4.0 et mousse visco-élastique SH 1.4. Revêtement à structure alvéolée. Rembouillage des alvéoles : 90% duvet d'oie, 10% duvet de canard.	Zitkussens	Meerlaagse kussenopbouw van koudschuim SG 45, stramheid 4.0 en visco-elastisch schuim, stramheid 1.4. Afdekking afgewerkt als kamerkussen. Vulling in de afzonderlijke kamers: 90% ganzenveren, 10% eendenveren.
Dossier	Rembouillage à deux couches : mousse à froid RG 32, SH 2.5 et RG 27, SH 1.6 pour la couche supérieure.	Rug	Tweelaags volledige stoffering van koudschuim SG 32, stramheid 2.5 en SG 27, stramheid 1.6 voor
Accoudoir	Revêtement de l'accoudoir en mousse polyéther RG 75, SH 13.0.	Zijkant	Armgedeelte van polyetherschuim SG 75, stramheid 13.0.
Revêtement intérieur	Revêtement intérieur en mousse contrecollée de 2,7 mm d'épaisseur avec armature en tissu à l'intérieur.	Onderbekleding	Onderbekleding van gelamineerd schuimstof 2,7 mm dik met weefselversterking aan de binnenkant.
Modèles de pied	Pied en acier chromé brillant, 30 mm de diamètre, 180 mm de hauteur hauteur de siège 44 cm ou 160 mm de hauteur hauteur de siège 42 cm ou patins en acier plat chromé brillant, 50mm de largeur, 150 mm de hauteur hauteur de siège 41 cm	Pootuitvoeringen	Stalen poot glanzend verchromd, diameter 30 mm, hoogte 180 mm zithoogte 44 cm of hoogte 160 mm zithoogte 42 cm of plat stalen sleevoet, glanzend verchromd, 50 mm breed, 150 mm hoog zithoogte 41 cm .
Caractéristiques	Corps de siège et coussins déhoussables.	Bijzondere kenmerken	Verwisselbare hoezen bij romp en kussens.

Füsse / Legs / Pieds / Voeten



D 2

Metallfuss rund,
hochglanz verchromt
Ø 30 mm,
**160 mm hoch
für Sitzhöhe 42 cm**

Metal leg, round,
highly polished chromium-plated
Ø 30 mm,
**height 160 mm
for seat height 42 cm**

D 2

Pied métallique rond,
chromé brillant
Ø 30 mm,
**160 mm de haut
pour hauteur de siège 42 cm**

Ronde metalen voet,
glanzend verchromd
Ø 30 mm,
**160 mm hoog
voor zithoogte 42 cm**

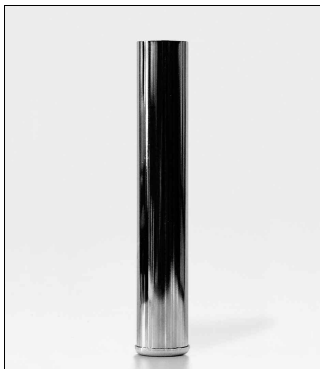

D 15

Metallfuss rund,
hochglanz verchromt
Ø 30 mm,
**180 mm hoch
für Sitzhöhe 44 cm**

Metal leg, round,
highly polished chromium-plated
Ø 30 mm,
**height 180 mm
for seat height 44 cm**

D 15

Pied métallique rond,
chromé brillant
Ø 30 mm,
**180 mm de haut
pour hauteur de siège 44 cm**

Ronde metalen voet,
glanzend verchromd
Ø 30 mm,
**180 mm hoog
voor zithoogte 44 cm**

Kufen / Skids / Patin / Sleeveoeten



Kufe 5 / Skid 5

Metall Flachstahl, 50 mm breit,
150 mm hoch,
Sitzhöhe 41 cm
hochglanz verchromt
Aufpreis pro Kufe € 50,-

Flat rolled steel metal foot,
50 mm wide,
150 mm high,
seat height 41 cm
highly polished chromium-plated
Extra charge per skid € 50,-

Patin 5 / Sleeveoet 5

Pied en acier plat, 50 mm de large,
hauteur 150 mm
hauteur de siège 41 cm
chromé brillant
Supplément par patin € 50,-

Metaal sleeveoet van platstaal,
50 mm breed,
150 mm hoog,
zithoogte 41 cm
glanzend verchromd
Meerprijs per sleeveoet € 50,-