

600.290 L

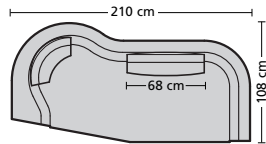

600.290 R

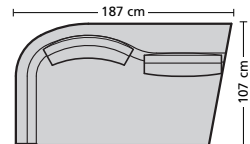

600.250 L

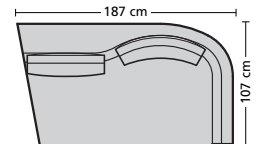

600.250 R

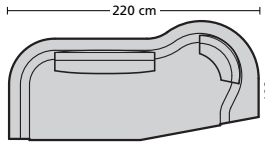

600.291 L

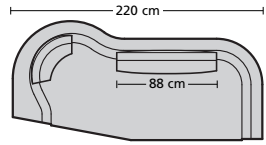

600.291 R

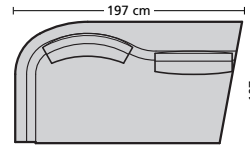

600.251 L

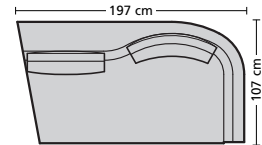

600.251 R

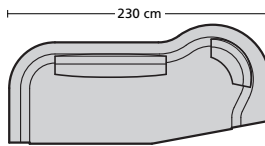

600.292 L

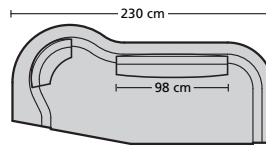

600.292 R

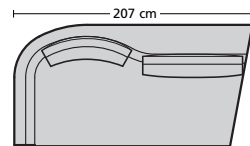

600.252 L

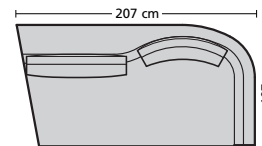

600.252 R

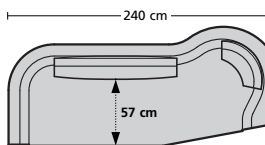

600.293 L

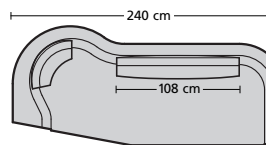

600.293 R

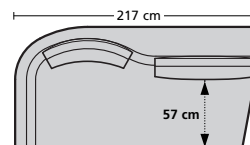

600.253 L

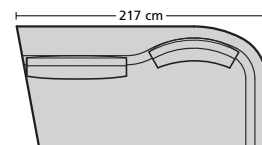

600.253 R

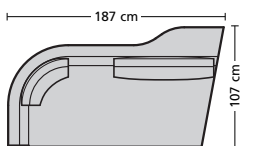

600.260 L

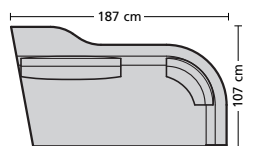

600.260 R

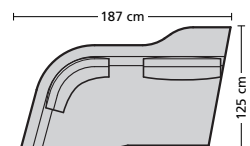

600.270 L

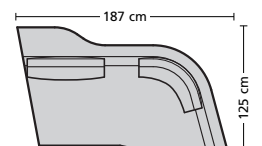

600.270 R

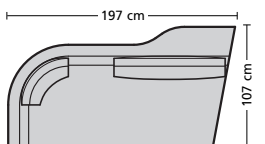

600.261 L

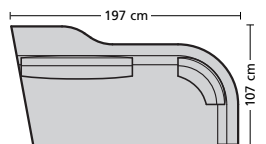

600.261 R

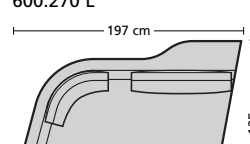

600.271 L

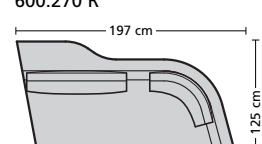

600.271 R

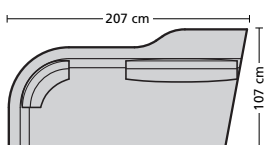

600.262 L

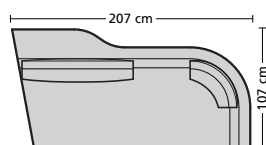

600.262 R

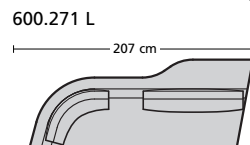

600.272 L

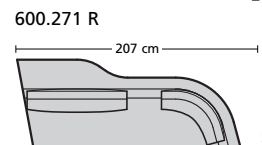

600.272 R

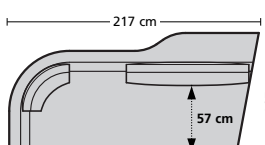

600.263 L

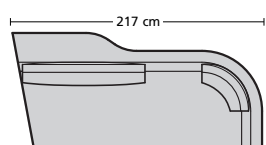

600.263 R

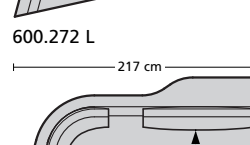

600.273 L

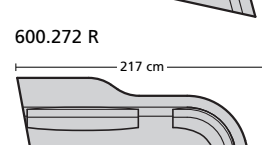

600.273 R

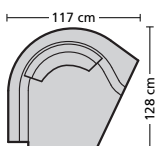

600.770 L

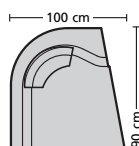

600.780 L

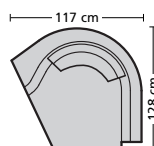

600.770 R

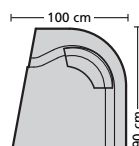

600.780 R

**Aufgrund von unterschiedlichen Modellgrundrissen und individuellem Sitzverhalten wird nur die Standardsitztiefe mit ca. 57 cm angegeben.**

Due to the various model layouts and individual seating options, the standard seat depth is given as approx. 57cm.

En raison des différents plans des modèles et des différentes manières personnelles de s'asseoir, seule la profondeur d'assise standard est indiquée (57 cm).

Vanwege verschillende modeltekeningen en individueel zitgedrag wordt alleen de standaard zitdiepte met ca. 57 cm aangegeven.

# D600 SPACE

## Kombinationsbeispiele / Arrangements

Exemples de composition / Combinatie voorbeelden

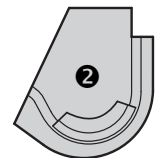
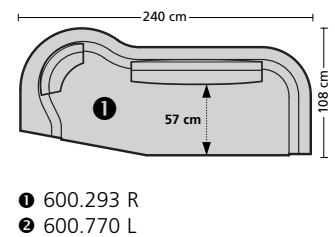
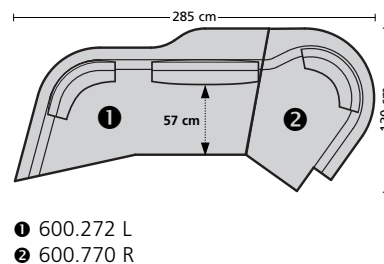
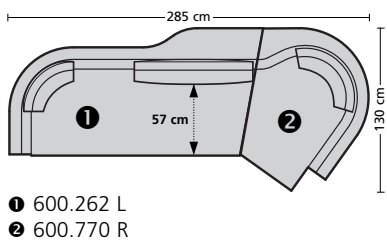
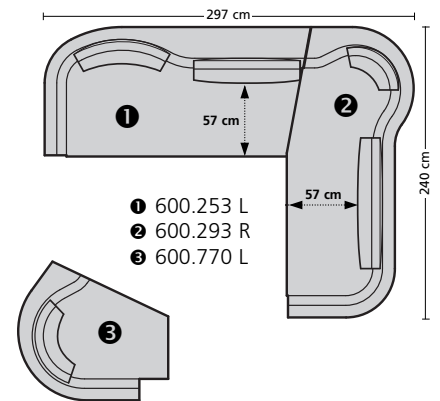
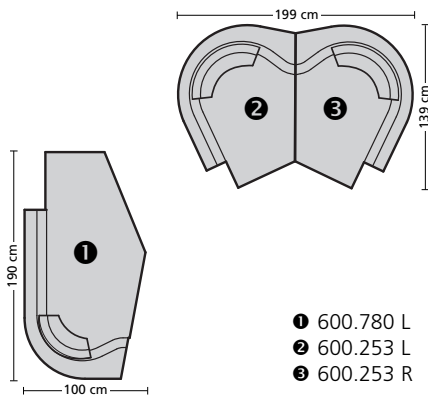
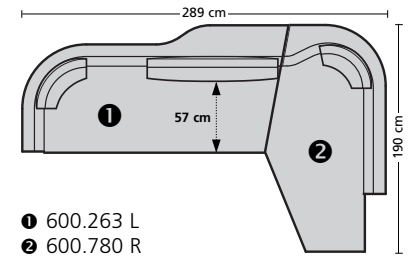
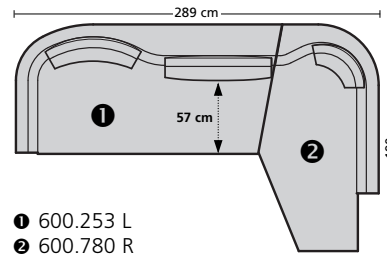
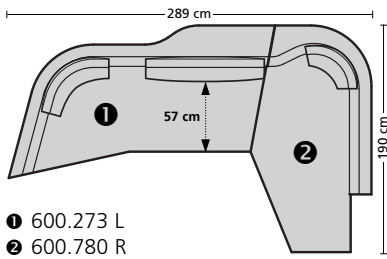

### Berechnung des Breitenstellmaßes

**Anreihsofas bei Kombinationen mit Sofas: Breite + Tiefe -28 cm**

**Anreihsofas bei Kombination mit Longchair: Breite + Breite -28 cm**

**Anreihsofas bei Kombination mit Element: Breite + Breite -39 cm**

Calculating the width dimension

Add-on sofa when combined with sofas: width + depth -28 cm

Add-on sofa when combined with long chair: width + width -28 cm

Add-on sofa when combined with element: width + width -39 cm

Calcul de la largeur d'implantation

Canapés juxtaposables pour les compositions avec canapés : largeur + profondeur -28 cm

Canapés juxtaposables pour les compositions avec méridienne : largeur + largeur -28 cm





Canapés juxtaposables pour les compositions avec chauffeuse : largeur + largeur -39 cm

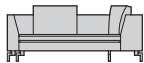
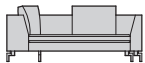
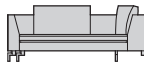
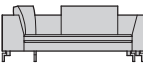
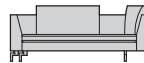

Berekening van de breedtestelmaat

aanbouwsofa's bij combinaties met sofa's: breedte + diepte -28 cm

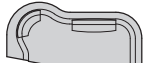
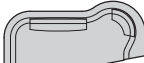
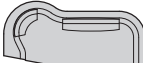
aanbouwsofa's bij combinaties met longchair: breedte + breedte -28 cm

aanbouwsofa's bij combinaties met element: breedte + breedte -39 cm



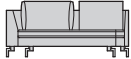
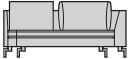
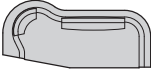
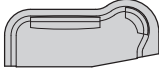
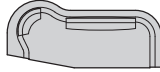
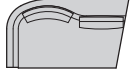
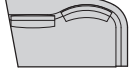

						
						
<b>Breite</b> / Width / Largeur / Breedte		Sofa links 2 1/2-sitzig 210 cm	Sofa rechts 2 1/2-sitzig 210 cm	Sofa links 2 1/2-sitzig 220 cm	Sofa rechts 2 1/2-sitzig 220 cm	Sofa links 2 1/2-sitzig 230 cm
<b>Tiefe</b> / Depth / Profondeur / Diepte		108 cm	108 cm	108 cm	108 cm	108 cm
<b>Höhe</b> / Height / Hauteur / Hoogte		86 cm	86 cm	86 cm	86 cm	86 cm
<b>Sitzhöhe</b> / Seat height / Hauteur de siège / Zithoogte		45 cm	45 cm	45 cm	45 cm	45 cm
<b>Sitztiefe</b> / Seat depth / Profondeur siège / Zitdiepte		57 cm	57 cm	57 cm	57 cm	57 cm
<b>Bestell-Nr.</b> / Order no. / N° de commande / Ordernr.		<b>D600.290 L</b>	<b>D600.290 R</b>	<b>D600.291 L</b>	<b>D600.291 R</b>	<b>D600.292 L</b>
<b>Stoffgruppe</b>	12	<b>2775</b>	<b>2775</b>	<b>2875</b>	<b>2875</b>	<b>3075</b>
Fabric category	13	<b>2875</b>	<b>2875</b>	<b>2975</b>	<b>2975</b>	<b>3175</b>
Catégorie de tissu	14	<b>2975</b>	<b>2975</b>	<b>3075</b>	<b>3075</b>	<b>3275</b>
Stofgroep	15	<b>2995</b>	<b>2995</b>	<b>3095</b>	<b>3095</b>	<b>3295</b>
	16	<b>3075</b>	<b>3075</b>	<b>3175</b>	<b>3175</b>	<b>3375</b>
	17	<b>3175</b>	<b>3175</b>	<b>3275</b>	<b>3275</b>	<b>3475</b>
	18	<b>3275</b>	<b>3275</b>	<b>3375</b>	<b>3375</b>	<b>3575</b>
	19	<b>3375</b>	<b>3375</b>	<b>3475</b>	<b>3475</b>	<b>3675</b>
	20	<b>3475</b>	<b>3475</b>	<b>3575</b>	<b>3575</b>	<b>3775</b>
<b>Avantgarde</b>		<b>3275</b>	<b>3275</b>	<b>3375</b>	<b>3375</b>	<b>3575</b>
<b>Ledergruppe</b>	Derby	<b>3875</b>	<b>3875</b>	<b>3975</b>	<b>3975</b>	<b>4175</b>
Leather category	Touch	<b>3975</b>	<b>3975</b>	<b>4275</b>	<b>4275</b>	<b>4475</b>
Catégorie de cuir	Premium	<b>4275</b>	<b>4275</b>	<b>4375</b>	<b>4375</b>	<b>4575</b>
Leergroep	Nature	<b>4575</b>	<b>4575</b>	<b>4875</b>	<b>4875</b>	<b>5075</b>
	Imperial	<b>4975</b>	<b>4975</b>	<b>5275</b>	<b>5275</b>	<b>5475</b>
<b>Preis bei Stoffzugabe</b>		<b>2695</b>	<b>2695</b>	<b>2775</b>	<b>2775</b>	<b>2975</b>
Price in customer's own fabric						
Prix sans matériau de recouvrement						
Prijs bij eigen stof						
<b>Stoffbedarf, ohne Rapport</b>						
Fabric requirement, without pattern						
Métrage de tissu nécessaire, sans raccord						
Benodigde bekledingsstof zonder rapport						
<b>140 cm breit</b> / wide / large / breedte		8,15 m	8,15 m	8,60 m	8,60 m	8,50 m
<b>130 cm breit</b> / wide / large / breedte		8,80 m	8,80 m	9,25 m	9,25 m	9,35 m

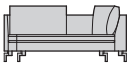
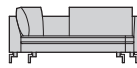
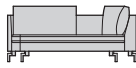
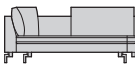
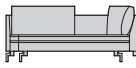
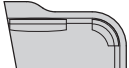
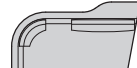
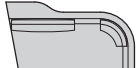
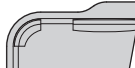
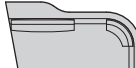
					
					
	Sofa rechts 2 1/2-sitzig	Sofa links 2 1/2-sitzig	Sofa rechts 2 1/2-sitzig	Anreihsofa links 2-sitzig	Anreihsofa rechts 2-sitzig
<b>Breite</b> / Width / Largeur / Breedte	230 cm	240 cm	240 cm	187 cm	187 cm
<b>Tiefe</b> / Depth / Profondeur / Diepte	108 cm	108 cm	108 cm	107 cm	107 cm
<b>Höhe</b> / Height / Hauteur / Hoogte	86 cm	86 cm	86 cm	86 cm	86 cm
<b>Sitzhöhe</b> / Seat height / Hauteur de siège / Zithoogte	45 cm	45 cm	45 cm	45 cm	45 cm
<b>Sitztiefe</b> / Seat depth / Profondeur siège / Zitdiepte	57 cm	57 cm	57 cm	57 cm	57 cm
<b>Bestell-Nr.</b> / Order no. / N° de commande / Ordernu.	<b>D600.292 R</b>	<b>D600.293 L</b>	<b>D600.293 R</b>	<b>D600.250 L</b>	<b>D600.250 R</b>
<b>Stoffgruppe</b>	12 <b>3075</b>	<b>3175</b>	<b>3175</b>	<b>2495</b>	<b>2495</b>
Fabric category	13 <b>3175</b>	<b>3275</b>	<b>3275</b>	<b>2550</b>	<b>2550</b>
Catégorie de tissu	14 <b>3275</b>	<b>3375</b>	<b>3375</b>	<b>2595</b>	<b>2595</b>
Stofgroep	15 <b>3295</b>	<b>3395</b>	<b>3395</b>	<b>2650</b>	<b>2650</b>
	16 <b>3375</b>	<b>3475</b>	<b>3475</b>	<b>2695</b>	<b>2695</b>
	17 <b>3475</b>	<b>3575</b>	<b>3575</b>	<b>2775</b>	<b>2775</b>
	18 <b>3575</b>	<b>3675</b>	<b>3675</b>	<b>2875</b>	<b>2875</b>
	19 <b>3675</b>	<b>3775</b>	<b>3775</b>	<b>2975</b>	<b>2975</b>
	20 <b>3775</b>	<b>3875</b>	<b>3875</b>	<b>3075</b>	<b>3075</b>
<b>Avantgarde</b>	<b>3575</b>	<b>3675</b>	<b>3675</b>	<b>2875</b>	<b>2875</b>
<b>Ledergruppe</b>	Derby <b>4175</b>	<b>4275</b>	<b>4275</b>	<b>3575</b>	<b>3575</b>
Leather category	Touch <b>4475</b>	<b>4575</b>	<b>4575</b>	<b>3775</b>	<b>3775</b>
Catégorie de cuir	Premium <b>4575</b>	<b>4675</b>	<b>4675</b>	<b>3875</b>	<b>3875</b>
Leergroep	Nature <b>5075</b>	<b>5175</b>	<b>5175</b>	<b>4175</b>	<b>4175</b>
	Imperial <b>5475</b>	<b>5575</b>	<b>5575</b>	<b>4575</b>	<b>4575</b>
<b>Preis bei Stoffzugabe</b>	<b>2975</b>	<b>3075</b>	<b>3075</b>	<b>2375</b>	<b>2375</b>
Price in customer's own fabric					
Prix sans matériau de recouvrement					
Prijs bij eigen stof					
<b>Stoffbedarf, ohne Rapport</b>					
Fabric requirement, without pattern					
Métrage de tissu nécessaire, sans raccord					
Benodigde bekledingsstof zonder rapport					
<b>140 cm breit</b> / wide / large / breedte	8,50 m	9,25 m	9,25 m	7,40 m	7,40 m
<b>130 cm breit</b> / wide / large / breedte	9,35 m	9,95 m	9,95 m	8,25 m	8,25 m

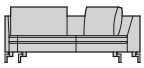
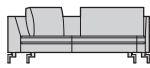
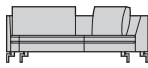

					
					
	Anreihsofa rechts	Anreihsofa links	Anreihsofa rechts	Anreihsofa links	Anreihsofa rechts
	2-sitzig	2-sitzig	2-sitzig	2 1/2-sitzig	2 1/2-sitzig
<b>Breite</b> / Width / Largeur / Breedte	187 cm	197 cm	197 cm	207 cm	207 cm
<b>Tiefe</b> / Depth / Profondeur / Diepte	107 cm	107 cm	107 cm	107 cm	107 cm
<b>Höhe</b> / Height / Hauteur / Hoogte	86 cm	86 cm	86 cm	86 cm	86 cm
<b>Sitzhöhe</b> / Seat height / Hauteur de siège / Zithoogte	45 cm	45 cm	45 cm	45 cm	45 cm
<b>Sitztiefe</b> / Seat depth / Profondeur siège / Zitdiepte	57 cm	57 cm	57 cm	57 cm	57 cm
<b>Bestell-Nr.</b> / Order no. / N° de commande / Ordernu.	<b>D600.260 R</b>	<b>D600.261 L</b>	<b>D600.261 R</b>	<b>D600.262 L</b>	<b>D600.262 R</b>
<b>Stoffgruppe</b>	12 <b>2375</b>	13 <b>2425</b>	14 <b>2425</b>	15 <b>2625</b>	16 <b>2625</b>
Fabric category	13 <b>2425</b>	14 <b>2475</b>	15 <b>2475</b>	16 <b>2675</b>	17 <b>2675</b>
Catégorie de tissu	14 <b>2475</b>	15 <b>2525</b>	16 <b>2525</b>	17 <b>2725</b>	18 <b>2725</b>
Stofgroep	15 <b>2525</b>	16 <b>2575</b>	17 <b>2575</b>	18 <b>2775</b>	19 <b>2775</b>
	16 <b>2575</b>	17 <b>2625</b>	18 <b>2625</b>	19 <b>2825</b>	20 <b>2825</b>
	17 <b>2650</b>	18 <b>2695</b>	19 <b>2695</b>	20 <b>2895</b>	21 <b>2895</b>
	18 <b>2750</b>	19 <b>2795</b>	20 <b>2795</b>	21 <b>2995</b>	22 <b>2995</b>
	19 <b>2850</b>	20 <b>2895</b>	21 <b>2895</b>	22 <b>3095</b>	23 <b>3095</b>
	20 <b>2895</b>	21 <b>2975</b>	22 <b>2975</b>	23 <b>3175</b>	24 <b>3175</b>
<b>Avantgarde</b>	<b>2675</b>	<b>2775</b>	<b>2775</b>	<b>2975</b>	<b>2975</b>
<b>Ledergruppe</b>	Derby <b>3375</b>	Touch <b>3475</b>	Premium <b>3475</b>	Nature <b>3675</b>	Imperial <b>3675</b>
Leather category	Touch <b>3575</b>	Premium <b>3675</b>	Nature <b>3675</b>	Imperial <b>3875</b>	Imperial <b>3875</b>
Catégorie de cuir	Premium <b>3675</b>	Nature <b>3775</b>	Imperial <b>3775</b>	Imperial <b>3975</b>	Imperial <b>3975</b>
Leergroep	Nature <b>4075</b>	Imperial <b>4175</b>	Imperial <b>4175</b>	Imperial <b>4375</b>	Imperial <b>4375</b>
	Imperial <b>4375</b>	Imperial <b>4575</b>	Imperial <b>4575</b>	Imperial <b>4775</b>	Imperial <b>4775</b>
<b>Preis bei Stoffzugabe</b>	<b>2275</b>	<b>2350</b>	<b>2350</b>	<b>2550</b>	<b>2550</b>
Price in customer's own fabric					
Prix sans matériau de recouvrement					
Prijs bij eigen stof					
<b>Stoffbedarf, ohne Rapport</b>					
Fabric requirement, without pattern					
Métrage de tissu nécessaire, sans raccord					
Benodigde bekledingsstof zonder rapport					
<b>140 cm breit</b> / wide / large / breedte	7,05 m	7,40 m	7,40 m	7,60 m	7,60 m
<b>130 cm breit</b> / wide / large / breedte	7,60 m	8,25 m	8,25 m	8,50 m	8,50 m

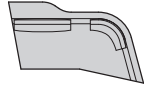
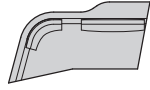
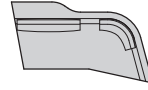

					
					
	Anreihsofa rechts 2 1/2-sitzig	Anreihsofa links 2 1/2-sitzig	Anreihsofa rechts 2 1/2-sitzig	Element links	Element rechts
<b>Breite</b> / Width / Largeur / Breedte	207 cm	217 cm	217 cm	117 cm	117 cm
<b>Tiefe</b> / Depth / Profondeur / Diepte	125 cm	125 cm	125 cm	128 cm	128 cm
<b>Höhe</b> / Height / Hauteur / Hoogte	86 cm	86 cm	86 cm	86 cm	86 cm
<b>Sitzhöhe</b> / Seat height / Hauteur de siège / Zithoogte	45 cm	45 cm	45 cm	45 cm	45 cm
<b>Sitztiefe</b> / Seat depth / Profondeur siège / Zitdiepte	57 cm	57 cm	57 cm	57 cm	57 cm
<b>Bestell-Nr.</b> / Order no. / N° de commande / Ordernr.	<b>D600.272 R</b>	<b>D600.273 L</b>	<b>D600.273 R</b>	<b>D600.770 L</b>	<b>D600.770 R</b>
<b>Stoffgruppe</b>	12 <b>2775</b>	<b>2875</b>	<b>2875</b>	<b>1895</b>	<b>1895</b>
Fabric category	13 <b>2850</b>	<b>2950</b>	<b>2950</b>	<b>1950</b>	<b>1950</b>
Catégorie de tissu	14 <b>2895</b>	<b>2995</b>	<b>2995</b>	<b>1975</b>	<b>1975</b>
Stofgroep	15 <b>2950</b>	<b>3050</b>	<b>3050</b>	<b>2150</b>	<b>2150</b>
	16 <b>2995</b>	<b>3095</b>	<b>3095</b>	<b>2175</b>	<b>2175</b>
	17 <b>3075</b>	<b>3175</b>	<b>3175</b>	<b>2225</b>	<b>2225</b>
	18 <b>3175</b>	<b>3275</b>	<b>3275</b>	<b>2275</b>	<b>2275</b>
	19 <b>3275</b>	<b>3375</b>	<b>3375</b>	<b>2395</b>	<b>2395</b>
	20 <b>3375</b>	<b>3475</b>	<b>3475</b>	<b>2450</b>	<b>2450</b>
<b>Avantgarde</b>	<b>3175</b>	<b>3275</b>	<b>3275</b>	<b>2275</b>	<b>2275</b>
<b>Ledergruppe</b>	Derby <b>3775</b>	<b>3875</b>	<b>3875</b>	<b>2650</b>	<b>2650</b>
Leather category	Touch <b>3975</b>	<b>4075</b>	<b>4075</b>	<b>2750</b>	<b>2750</b>
Catégorie de cuir	Premium <b>4075</b>	<b>4175</b>	<b>4175</b>	<b>2775</b>	<b>2775</b>
Leergroep	Nature <b>4475</b>	<b>4575</b>	<b>4575</b>	<b>2975</b>	<b>2975</b>
	Imperial <b>4775</b>	<b>4875</b>	<b>4875</b>	<b>3175</b>	<b>3175</b>
<b>Preis bei Stoffzugabe</b>	<b>2675</b>	<b>2775</b>	<b>2775</b>	<b>1850</b>	<b>1850</b>
Price in customer's own fabric					
Prix sans matériau de recouvrement					
Prijs bij eigen stof					
<b>Stoffbedarf, ohne Rapport</b>					
Fabric requirement, without pattern					
Métrage de tissu nécessaire, sans raccord					
Benodigde bekledingsstof zonder rapport					
<b>140 cm breit</b> / wide / large / breedte	7,70 m	8,05 m	8,05 m	4,95 m	4,95 m
<b>130 cm breit</b> / wide / large / breedte	8,70 m	8,95 m	8,95 m	5,65 m	5,65 m



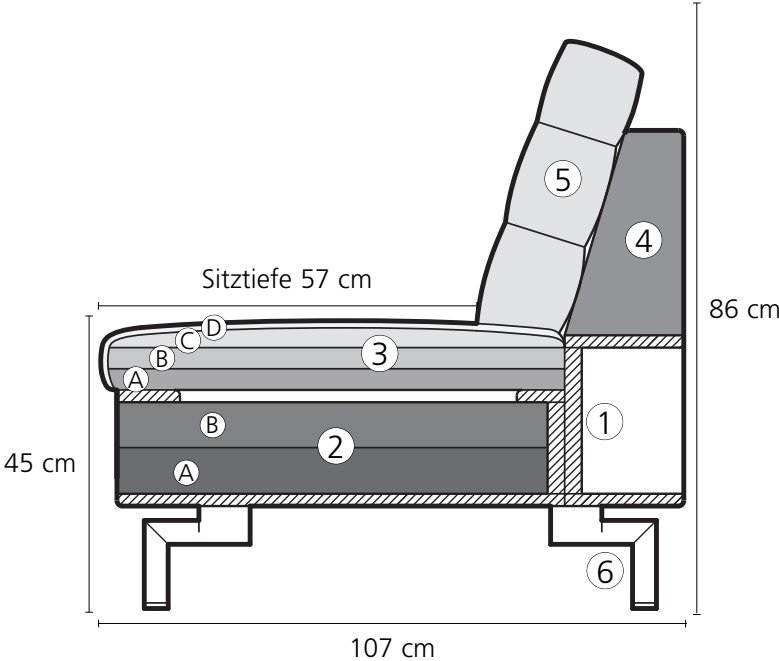

<b>Gestell</b>	Rahmenkonstruktion aus Schichtholz mit massiver Buche verdübelt und verleimt.	<b>Frame</b>	Frame construction plywood with solid beech, doweled and glued.
<b>Unterfederung</b>	Unterfederung aus hochtragfähigem Polyätherschaum <b>A</b> RG 43 / 2,8 <b>B</b> RG 50 / 2,0	<b>Spring base</b>	Highly durable polyether foam <b>A</b> density 43 / 2.8 <b>B</b> density 50 / 2.0
<b>Sitzkissen</b>	Vierschichtiger Polsteraufbau <b>A</b> Polyätherschaum, RG 43 / 5,0 <b>B</b> Kaltschaum, RG 42 / 4,5 <b>C</b> Polyätherschaum, RG 40 / 1,4 <b>D</b> Vliesabdeckung 345 g/m <sup>2</sup>	<b>Seat cushions</b>	Four-layered cushion structure <b>A</b> Polyether foam, density 43 / 5.0 <b>B</b> Cold foam, density 42 / 4.5 <b>C</b> Polyether foam, density 40 / 1.4 <b>D</b> Polyester padding 345 g/m <sup>2</sup>
<b>Rückenkorpus</b>	Dreipunkt Spezialschaum RG 33 / 15,0	<b>Back body</b>	Dreipunkt special foam density 33 / 15.0
<b>Rückenkissen</b>	Lose Kammerkissen mit Daunencharakter, Füllung Dreipunkt Selecta RG 80 (80%) und dauerelastische Vliesfasern (20%). Zur Pflege empfehlen wir ein regelmäßiges Aufschütteln der einzelnen Rückenkissen.	<b>Back cushions</b>	Loose chambered cushions with a downy character. Filled with Dreipunkt Selecta density 80 (80%) and permanent elastic polyester fibers (20%). The single back cushions should be plumped up on a regular basis.
<b>Füße</b>	Aluminium, matt oder hochglanz poliert. <b>Bitte bei Bestellung unbedingt angeben.</b>	<b>Legs</b>	Aluminum, matt or highly polished <b>Please specify in your order.</b>
<b>Kombinationsmöglichkeiten</b>	Sofa links/rechts mit Anreihsofas links/rechts Anreihsofas links/rechts mit Element links/rechts Anreihsofas links/rechts mit Longchair links/rechts	<b>Possible Combinations</b>	Sofa left/right with add-on sofas left/right Add-on sofas left/right with element left/right Add-on sofas left/right with long chair left/right
<b>Verbindungsbeslag</b>	Verbindungsbeschläge für Sofas werden mitgeliefert oder auf Wunsch montiert. <b>Bitte bei Bestellung unbedingt angeben.</b>	<b>Connecting fixtures</b>	Connecting fixtures for sofas are delivered with the order or fitted on request. <b>Please specify in your order.</b>

<b>Structure</b>	Structure en bois stratifié avec hêtre massif, chevillée et collée.	<b>Frame</b>	Geraamte van multiplex met massief beukenhout geplugd en vastgelijmd.
<b>Suspension</b>	Suspension en mousse de polyéther résistante <b>A</b> RG 43 / 2,8, <b>B</b> RG 50 / 2,0	<b>Vering</b>	Vering van zeer draagkrachtig polyetherschuim <b>A</b> RG 43 / 2,8 <b>B</b> RG 50 / 2,0
<b>Coussins d'assise</b>	Rembourrage à quatre couches <b>A</b> Mousse de polyéther, RG 43 / 5,0 <b>B</b> Mousse à froid, RG 42 / 4,5 <b>C</b> Mousse de polyéther, RG 40 / 1,4 <b>D</b> Revêtement fibres polyester 345 gr./qm	<b>Zitkussens</b>	Vier-laags vering <b>A</b> Polyetherschuim, RG 43 / 5,0 <b>B</b> Koud schuim, RG 42 / 4,5 <b>C</b> Polyetherschuim, RG 40 / 1,4 <b>D</b> Vliesbekleding 345 g/m <sup>2</sup>
<b>Dossier</b>	Mousse spéciale Dreipunkt RG 33 / 15,0.	<b>Rugromp</b>	Dreipunkt speciaal schuim RG 33 / 15,0
<b>Coussins de dossier</b>	Coussins amovibles à finition alvéolée type duvet, rembourrage Dreipunkt Selecta RG 80 (80%) et fibres polyester de rembourrage élastiques (20%) Pour l'entretien, nous recommandons de secouer régulièrement les coussins de dossier un par un.	<b>Rugkussens</b>	Losse kamerkussens met dons karakter, gevuld met een mengsel van Dreipunkt Selecta RG 80 (80%) en vormelastische vliesbekleding (20%). Voor een maximaal zitcomfort raden u aan de verschillende rugkussens regelmatig op te schudden.
<b>Pieds</b>	Aluminium, mat ou brillant. <b>A préciser impérativement à la commande.</b>	<b>Poten</b>	Aluminium, mat of glanzend gepolijst. <b>Gelieve dit bij de bestelling duidelijk te specificeren.</b>
<b>Possibilités de composition</b>	Canapé gauche/droite avec canapés juxtaposables gauche/droite Canapés juxtaposables gauche/droite avec éléments gauche/droite Canapés juxtaposables gauche/droite avec fauteuil de repos gauche/droite	<b>Combinatiemogelijkheden</b>	Sofa links/rechts met aanbouwsofa's links/rechts Aanbouwsofa's links/rechts met element links/rechts Aanbouwsofa's links/rechts met longchair links/rechts
<b>Ferrures d'assemblage</b>	Les ferrures d'assemblage pour les canapés peuvent être livrées ou montées sur demande. <b>A préciser impérativement à la commande.</b>	<b>Verbindingsbeslag</b>	Verbindingsbeslag voor de sofa's wordt meegeleverd of op aanvraag gemonteerd. <b>Gelieve dit bij de bestelling duidelijk te specificeren.</b>

## Füsse / Legs / Pieds / Voeten



### D 73

Fuss Aluminiumguss oval,  
37 x 25 mm,  
155 mm hoch,  
**hochglanz poliert**

Oval cast aluminium,  
37 x 25 mm,  
height 155 mm,  
**high gloss polished**

### D 73

Pied fonte d'aluminium ovale,  
37 x 25 mm  
155 mm de haut,  
**poli brillant**

Ovale gietaluminium voet,  
37 x 25 mm,  
155 mm hoog,  
**glanzend gepolijst**



### D 73

Fuss Aluminiumguss oval,  
37 x 25 mm,  
155 mm hoch,  
**matt poliert**

Oval cast aluminium,  
37 x 25 mm,  
height 155 mm,  
**mat polished**

### D 73

Pied fonte d'aluminium ovale,  
37 x 25 mm  
155 mm de haut,  
**poli mat**

Ovale gietaluminium voet,  
37 x 25 mm,  
155 mm hoog,  
**mat gepolijst**