

D450 LOUNGE

Produktumfang / Product range / Gamme des produits / Productomvang

Sitztiefe 54 cm

Seat depth 54 cm
Profondeur de siège 54 cm
Zitdiepte 54 cm

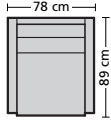

450.12

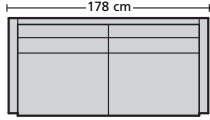

450.26

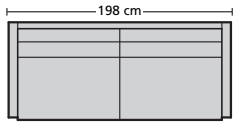

450.27

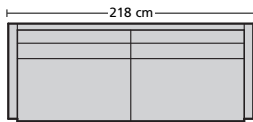

450.28

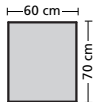

450.60 Hocker

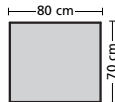

450.61 Hocker

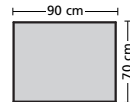

450.62 Hocker

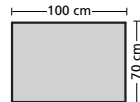

450.63 Hocker

Sitztiefe 62 cm

Seat depth 62 cm
Profondeur de siège 62 cm
Zitdiepte 62 cm

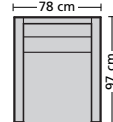

450.12

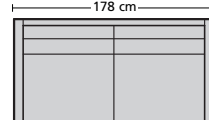

450.26

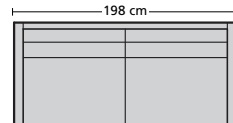



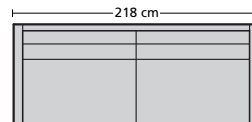





450.27

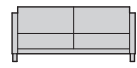

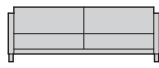





450.28

D450 LOUNGE









Sitztiefe 54 cm / Seat depth / Profondeur de siège / Zitdiepte

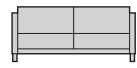

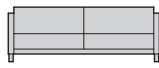



| | | | | | | |
|---|---|---|--|---|---|-------------|
| Sitztiefe bitte bei der Bestellung unbedingt angeben. Important - Specify seat depth in your order. Veuillez absolument indiquer à la commande la profondeur de siège. Gelieve de zitdiepte bij de bestelling te vermelden. |  |  |  |  |  | |
| |  |  |  |  |  | |
| | Sessel | Sofa 2 1/2-sitzig | Sofa 2 1/2-sitzig | Sofa 2 1/2-sitzig | Hocker | |
| Breite / Width / Largeur / Breedte | 78 cm | 178 cm | 198 cm | 218 cm | 60 cm | |
| Tiefe / Depth / Profondeur / Diepte | 89 cm | 89 cm | 89 cm | 89 cm | 70 cm | |
| Höhe / Height / Hauteur / Hoogte | 77 cm | 77 cm | 77 cm | 77 cm | 42 cm | |
| Sitzhöhe / Seat height / Hauteur de siège / Zithoogte | 42 cm | 42 cm | 42 cm | 42 cm | - | |
| Sitztiefe / Seat depth / Profondeur siège / Zitdiepte | 54 cm | 54 cm | 54 cm | 54 cm | - | |
| Bestell-Nr. / Order no. / N° de commande / Ordernu. | D450.12 | D450.26 | D450.27 | D450.28 | D450.60 | |
| Stoffgruppe | 12 | 1375 | 2350 | 2450 | 2550 | 695 |
| Fabric category | 13 | 1395 | 2425 | 2525 | 2595 | 705 |
| Catégorie de tissu | 14 | 1450 | 2450 | 2575 | 2650 | 715 |
| Stofgroep | 15 | 1475 | 2525 | 2625 | 2725 | 725 |
| | 16 | 1495 | 2575 | 2675 | 2775 | 735 |
| | 17 | 1550 | 2675 | 2775 | 2875 | 750 |
| | 18 | 1575 | 2775 | 2875 | 2975 | 775 |
| | 19 | 1675 | 2875 | 2975 | 3175 | 825 |
| | 20 | 1725 | 2975 | 3075 | 3275 | 850 |
| Avantgarde | | 1575 | 2775 | 2875 | 2975 | 775 |
| Ledergruppe | Derby | 2075 | 3575 | 3775 | 3975 | 950 |
| Leather category | Touch | 2175 | 3675 | 3875 | 4075 | 975 |
| Catégorie de cuir | Premium | 2275 | 3775 | 3975 | 4175 | 995 |
| Leergroep | Nature | 2450 | 3975 | 4375 | 4575 | 1075 |
| | Imperial | 2675 | 4575 | 4875 | 4975 | 1125 |
| Preis bei Stoffzugabe | | 1325 | 2275 | 2375 | 2475 | 675 |
| Price in customer's own fabric | | | | | | |
| Prix sans matériau de recouvrement | | | | | | |
| Prijs bij eigen stof | | | | | | |
| Stoffbedarf, ohne Rapport | | | | | | |
| Fabric requirement, without pattern | | | | | | |
| Métrage de tissu nécessaire, sans raccord | | | | | | |
| Benodigde bekledingsstof zonder rapport | | | | | | |
| 140 cm breit / wide / large / breedte | | 4,75 m | 8,40 m | 9,00 m | 9,70 m | 1,55 m |
| 130 cm breit / wide / large / breedte | | 5,40 m | 9,00 m | 9,70 m | 10,45 m | 1,75 m |

| | | | | | |
|---|---|---|---|--|--|
| Sitztiefe bitte bei der Bestellung unbedingt angeben. Important - Specify seat depth in your order. Veuillez absolument indiquer à la commande la profondeur de siège. Gelieve de zitdiepte bij de bestelling te vermelden. |  |  |  | | |
| |  |  |  | | |
| | Hocker | Hocker | Hocker | | |
| Breite / Width / Largeur / Breedte | 80 cm | 90 cm | 100 cm | | |
| Tiefe / Depth / Profondeur / Diepte | 70 cm | 70 cm | 70 cm | | |
| Höhe / Height / Hauteur / Hoogte | 42 cm | 42 cm | 42 cm | | |
| Sitzhöhe / Seat height / Hauteur de siège / Zithoogte | - | - | - | | |
| Sitztiefe / Seat depth / Profondeur siège / Zitdiepte | - | - | - | | |
| Bestell-Nr. / Order no. / N° de commande / Ordernu. | D450.61 | D450.62 | D450.63 | | |
| Stoffgruppe | 12 750 | 13 825 | 14 850 | | |
| Fabric category | 13 775 | 14 830 | 15 875 | | |
| Catégorie de tissu | 14 795 | 15 835 | 16 885 | | |
| Stofgroep | 15 825 | 16 850 | 17 895 | | |
| | 16 835 | 17 875 | 18 925 | | |
| | 17 855 | 18 885 | 19 950 | | |
| | 18 875 | 19 895 | 20 975 | | |
| | 19 895 | 20 950 | | | |
| | 20 925 | | | | |
| Avantgarde | 875 | 895 | 975 | | |
| Ledergruppe | Derby 1025 | Touch 1075 | Premium 1125 | | |
| Leather category | Touch 1050 | Premium 1125 | Nature 1175 | | |
| Catégorie de cuir | Premium 1075 | Nature 1175 | Imperial 1225 | | |
| Leergroep | Nature 1175 | Imperial 1225 | | | |
| | Imperial 1250 | | | | |
| Preis bei Stoffzugabe | 725 | 795 | 825 | | |
| Price in customer's own fabric | | | | | |
| Prix sans matériau de recouvrement | | | | | |
| Prijs bij eigen stof | | | | | |
| Stoffbedarf, ohne Rapport | | | | | |
| Fabric requirement, without pattern | | | | | |
| Métrage de tissu nécessaire, sans raccord | | | | | |
| Benodigde bekledingsstof zonder rapport | | | | | |
| 140 cm breit / wide / large / breedte | 1,85 m | 2,05 m | 2,25 m | | |
| 130 cm breit / wide / large / breedte | 2,00 m | 2,15 m | 2,35 m | | |
| | | | | | |
| | | | | | |
| | | | | | |
| | | | | | |
| | | | | | |
| | | | | | |
| | | | | | |
| | | | | | |
| | | | | | |

D450 LOUNGE

Sitztiefe 62 cm / Seat depth / Profondeur de siège / Zitdiepte

| | | | | | | |
|---|---|---|--|---|---|-------------|
| Sitztiefe bitte bei der Bestellung unbedingt angeben. Important - Specify seat depth in your order. Veuillez absolument indiquer à la commande la profondeur de siège. Gelieve de zitdiepte bij de bestelling te vermelden. |  |  |  |  |  | |
| |  |  |  |  |  | |
| | Sessel | Sofa 2 1/2-sitzig | Sofa 2 1/2-sitzig | Sofa 2 1/2-sitzig | Hocker | |
| Breite / Width / Largeur / Breedte | 78 cm | 178 cm | 198 cm | 218 cm | 60 cm | |
| Tiefe / Depth / Profondeur / Diepte | 97 cm | 97 cm | 97 cm | 97 cm | 70 cm | |
| Höhe / Height / Hauteur / Hoogte | 77 cm | 77 cm | 77 cm | 77 cm | 42 cm | |
| Sitzhöhe / Seat height / Hauteur de siège / Zithoogte | 42 cm | 42 cm | 42 cm | 42 cm | - | |
| Sitztiefe / Seat depth / Profondeur siège / Zitdiepte | 62 cm | 62 cm | 62 cm | 62 cm | - | |
| Bestell-Nr. / Order no. / N° de commande / Ordernu. | D450.12 | D450.26 | D450.27 | D450.28 | D450.60 | |
| Stoffgruppe | 12 | 1425 | 2375 | 2495 | 2575 | 695 |
| Fabric category | 13 | 1450 | 2450 | 2575 | 2675 | 705 |
| Catégorie de tissu | 14 | 1475 | 2495 | 2625 | 2725 | 715 |
| Stofgroep | 15 | 1525 | 2550 | 2695 | 2775 | 725 |
| | 16 | 1550 | 2595 | 2775 | 2875 | 735 |
| | 17 | 1625 | 2725 | 2875 | 2975 | 750 |
| | 18 | 1675 | 2775 | 2975 | 3075 | 775 |
| | 19 | 1725 | 2875 | 3075 | 3175 | 825 |
| | 20 | 1775 | 2975 | 3175 | 3275 | 850 |
| Avantgarde | | 1675 | 2775 | 2975 | 3075 | 775 |
| Ledergruppe | Derby | 2175 | 3675 | 3875 | 3975 | 950 |
| Leather category | Touch | 2275 | 3775 | 3975 | 4275 | 975 |
| Catégorie de cuir | Premium | 2375 | 3875 | 4075 | 4375 | 995 |
| Leergroep | Nature | 2575 | 4275 | 4575 | 4775 | 1075 |
| | Imperial | 2775 | 4675 | 4975 | 5250 | 1125 |
| Preis bei Stoffzugabe | | 1395 | 2295 | 2395 | 2495 | 675 |
| Price in customer's own fabric | | | | | | |
| Prix sans matériau de recouvrement | | | | | | |
| Prijs bij eigen stof | | | | | | |
| Stoffbedarf, ohne Rapport | | | | | | |
| Fabric requirement, without pattern | | | | | | |
| Métrage de tissu nécessaire, sans raccord | | | | | | |
| Benodigde bekledingsstof zonder rapport | | | | | | |
| 140 cm breit / wide / large / breedte | | 4,75 m | 8,40 m | 9,00 m | 9,70 m | 1,55 m |
| 130 cm breit / wide / large / breedte | | 5,40 m | 9,00 m | 9,70 m | 10,45 m | 1,75 m |

| | | | | | |
|---|---|---|---|--|--|
| Sitztiefe bitte bei der Bestellung unbedingt angeben. Important - Specify seat depth in your order. Veuillez absolument indiquer à la commande la profondeur de siège. Gelieve de zitdiepte bij de bestelling te vermelden. |  |  |  | | |
| |  |  |  | | |
| | Hocker | Hocker | Hocker | | |
| Breite / Width / Largeur / Breedte | 80 cm | 90 cm | 100 cm | | |
| Tiefe / Depth / Profondeur / Diepte | 70 cm | 70 cm | 70 cm | | |
| Höhe / Height / Hauteur / Hoogte | 42 cm | 42 cm | 42 cm | | |
| Sitzhöhe / Seat height / Hauteur de siège / Zithoogte | - | - | - | | |
| Sitztiefe / Seat depth / Profondeur siège / Zitdiepte | - | - | - | | |
| Bestell-Nr. / Order no. / N° de commande / Ordernu. | D450.61 | D450.62 | D450.63 | | |
| Stoffgruppe | 12 750 | 13 825 | 14 850 | | |
| Fabric category | 13 775 | 14 830 | 15 875 | | |
| Catégorie de tissu | 14 795 | 15 835 | 16 885 | | |
| Stofgroep | 15 825 | 16 850 | 17 895 | | |
| | 16 835 | 17 875 | 18 925 | | |
| | 17 855 | 18 885 | 19 950 | | |
| | 18 875 | 19 895 | 20 975 | | |
| | 19 895 | 20 950 | 985 | | |
| | 20 925 | 975 | 995 | | |
| Avantgarde | 875 | 895 | 975 | | |
| Ledergruppe | Derby 1025 | Touch 1075 | Premium 1125 | | |
| Leather category | Touch 1050 | Premium 1125 | Nature 1175 | | |
| Catégorie de cuir | Premium 1075 | Nature 1175 | Imperial 1225 | | |
| Leergroep | Nature 1175 | Imperial 1225 | 1275 | | |
| | Imperial 1250 | 1325 | 1375 | | |
| Preis bei Stoffzugabe | 725 | 795 | 825 | | |
| Price in customer's own fabric | | | | | |
| Prix sans matériau de recouvrement | | | | | |
| Prijs bij eigen stof | | | | | |
| Stoffbedarf, ohne Rapport | | | | | |
| Fabric requirement, without pattern | | | | | |
| Métrage de tissu nécessaire, sans raccord | | | | | |
| Benodigde bekledingsstof zonder rapport | | | | | |
| 140 cm breit / wide / large / breedte | 1,85 m | 2,05 m | 2,25 m | | |
| 130 cm breit / wide / large / breedte | 2,00 m | 2,15 m | 2,35 m | | |
| | | | | | |
| | | | | | |
| | | | | | |
| | | | | | |
| | | | | | |
| | | | | | |
| | | | | | |
| | | | | | |

D450 LOUNGE

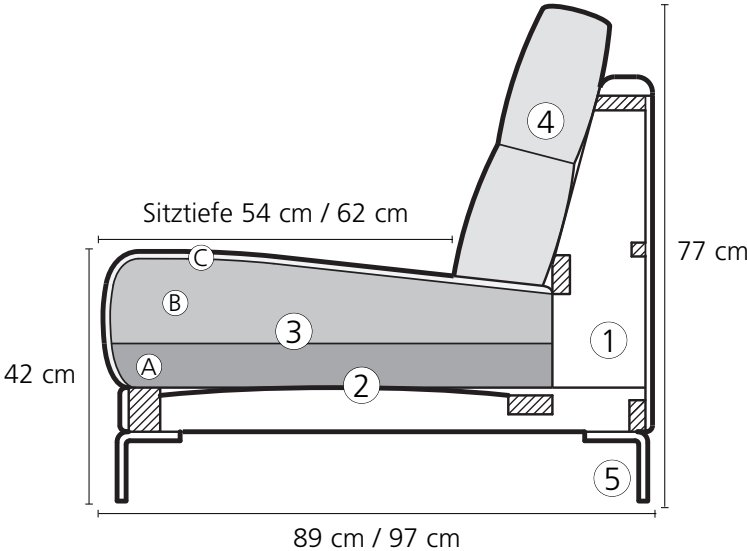

D450 LOUNGE

| | |
|----------------------|---|
| Gestell | Sitz- und Rückenrahmenkonstruktion Buche massiv, gedübelt und verleimt. |
| Unterfederung | Stahlwellenunterfederung mit Spezialvliesabdeckung |
| Sitzkissen | Dreischichtiger Polsteraufbau A Polyätherschaum, RG 43 / 5,0 B Kaltschaum, RG 37 / 3,4 C Elastische Vliesabdeckung 345 g/m ² |
| Rückenkissen | Lose Kammerkissen mit Daunencharakter, Füllung hochwertige Polyschaumstäbchen RG 28 (80%) und dauerelastischen Vliesfasern (20%). |
| Füsse | Abgewinkelter Flachstahl |
| Sitztiefen | 53 cm, gegen Mehrpreis 62 cm Bei Bestellung bitte unbedingt angeben. |
| Armlehnen | Breite 9 cm, Höhe 68 cm |
| Sitztiefen | 54 cm oder 62 cm |

| | |
|----------------------|---|
| Frame | Seat and back frame construction solid beech, doweled and glued. |
| Spring base | Sinuous spring base with special polyester padding |
| Seat cushions | Three-layered cushion structure A Polyether foam, density 43 / 5.0 B Cold foam, density 37 / 3.4 C Elastic polyester padding 345 g/m ² |
| Back cushions | Loose chambered cushions with a downy character. Filled with high-grade polyfoam sticks density 28 (80%) and permanent elastic polyester fibers (20%). |
| Legs | Angled flat steel |
| Seat depths | 53 cm or 62 cm for an additional charge Please specify in your order. |
| Armrests | Width 9 cm, height 68 cm |
| Seat depths | 54 cm or 62 cm |

| | |
|-----------------------------|---|
| Châssis | Châssis d'assise et de dossier en hêtre massif, chevillé et collé. |
| Suspension | Suspension en acier ondulé avec revêtement spécial. |
| Coussins d'assise | Rembouillage à trois couches A Mousse polyéther, RG 43 / 5,0 B Mousse à froid, RG 37 / 3,4 C Revêtement fibres de rembourrage élastique 345g/qm |
| Coussins de dossier | Coussins capitonnés amovibles type duvet, rembourrage particules de mousse polyéther très résistante RG 28 (80%) et fibres polyester de rembourrage élastiques (20%) |
| Pieds | Acier plat plié |
| Profondeurs d'assise | 53 cm ou 62 cm avec supplément A préciser impérativement à la commande! |
| Accoudoirs | Largeur 9 cm, hauteur 68 cm |
| Profondeurs d'assise | 54 cm ou 62 cm |

| | |
|-------------------|--|
| Frame | Zit- en ruggeraamte: massief beukenhout, geplugd en vastgelijmd. |
| Vering | Stalen springveren met speciale bekleding |
| Zitkussens | Drie-laags vering A Polyetherschium, RG 43 / 5,0 B Koud schuim, RG 37 / 3,4 C Vormelastische vliesbekleding 345 g/m ² |
| Rugkussens | Losse kamerkussens met donscharakter, gevuld met een mengsel van zeer draagkrachtige polyschuimstaafjes RG 28 (80%) en vormelastische vliesvezels (20%). |
| Poten | Haaksgewijs gebogen platstaal |
| Zitdieptes | Standaard 53 cm, tegen meerprijs 62 cm Gelieve dit bij de bestelling duidelijk te specificeren. |
| Zijstukken | Breedte 9 cm, hoogte 68 cm |
| Zitdieptes | 54 cm of 62 cm |

D450 LOUNGE

Füsse / Legs / Pieds / Voeten



D 17

Metall Flachstahl
60 x 110 x 8 mm,
hochglanz verchromt

Flat rolled steel metal foot
60 x 110 x 8 mm,
highly polished chromium-plated

D 17

Pied en acier plat
de 60 x 110 x 8 mm,
chromé brillant

Metalen voet van platstaal,
60 x 110 x 8 mm,
glanzend verchromd



D 17

Metall Flachstahl
60 x 110 x 8 mm,
matt verchromt

Flat rolled steel metal foot
60 x 110 x 8 mm,
mat chromium-plated

D 17

Pied en acier plat
de 60 x 110 x 8 mm,
chromé mat

Metalen voet van platstaal,
60 x 110 x 8 mm,
mat verchromd