

# D330 CLUB

Produktumfang / Product range / Gamme des produits / Productomvang

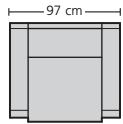

330.14

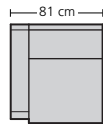

330.41 L

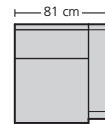

330.41 R

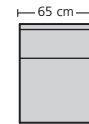

330.51

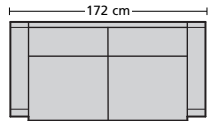

330.25

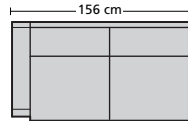

330.46 L

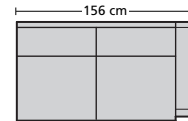

330.46 R

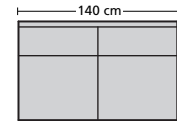

330.56

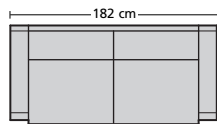

330.26

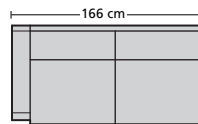

330.47 L

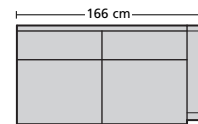

330.47 R

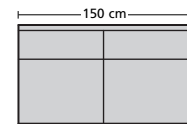

330.57

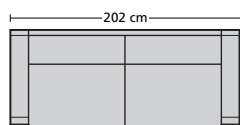

330.27

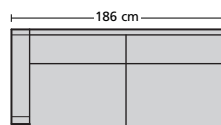

330.48 L

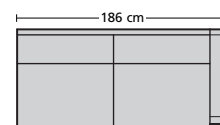

330.48 R

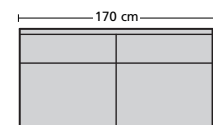

330.58

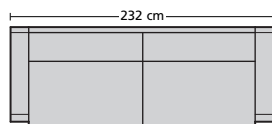

330.28

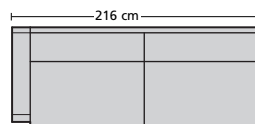

330.49 L

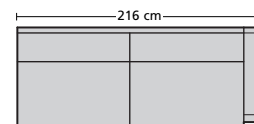

330.49 R

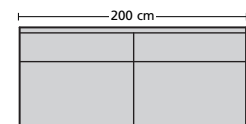

330.59

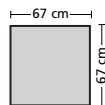

330.62  
Hocker

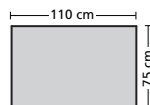

330.64  
Hocker

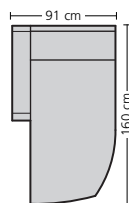

330.78 L

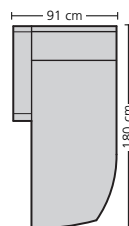

330.79 L

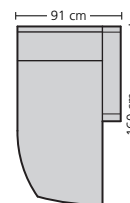

330.78 R

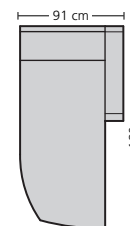

330.79 R

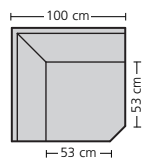

330.70

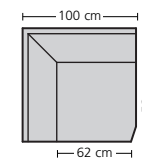

330.76 L

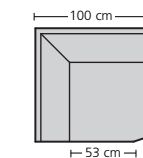







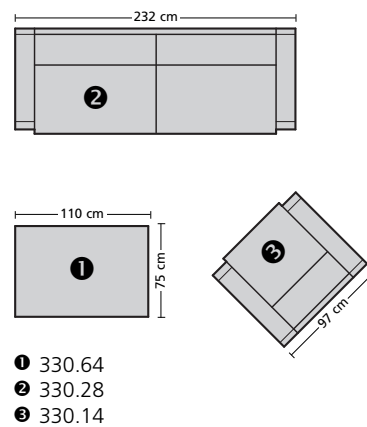
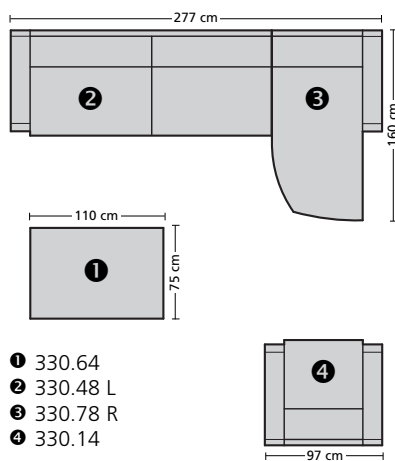
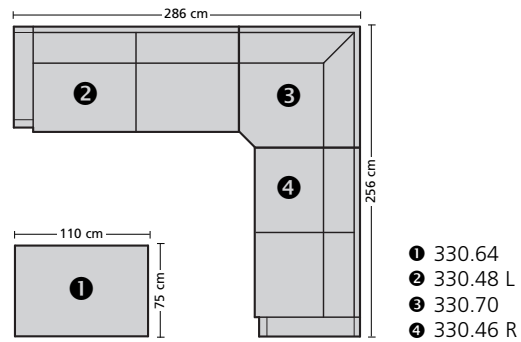
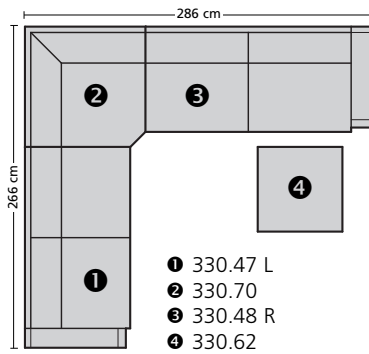
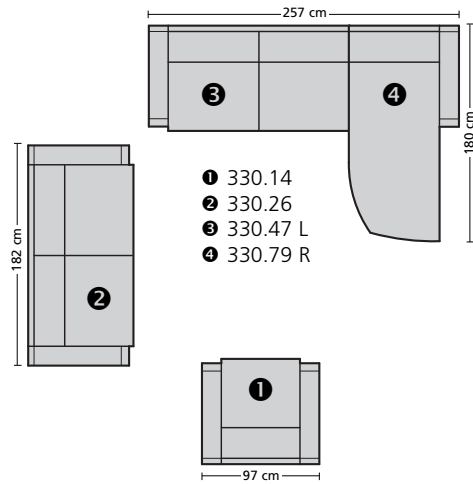
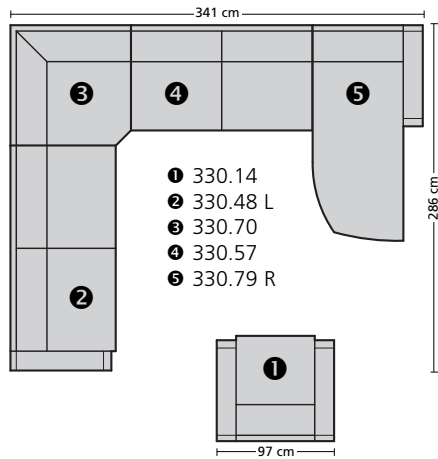

330.76 R



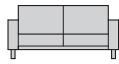

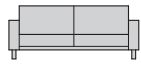
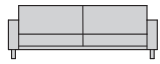

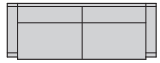

# D330 CLUB

## Kombinationsbeispiele / Arrangements

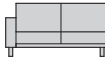
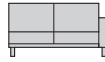



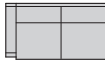
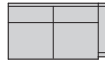



Exemples de composition / Combinatie voorbeelden

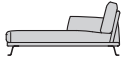
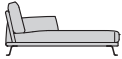





<b>Sitztiefe bitte bei der Bestellung unbedingt angeben.</b> Important - Specify seat depth in your order. Veuillez absolument indiquer à la commande la profondeur de siège. Gelieve de zitdiepte bij de bestelling te vermelden.					
					
	Sessel	Sofa 2-sitzig	Sofa 2 1/2-sitzig	Sofa 2 1/2-sitzig	Sofa 2 1/2-sitzig
<b>Breite</b> / Width / Largeur / Breedte	97 cm	172 cm	182 cm	202 cm	232 cm
<b>Tiefe</b> / Depth / Profondeur / Diepte	84 cm	84 cm	84 cm	84 cm	84 cm
<b>Höhe</b> / Height / Hauteur / Hoogte	81 cm	81 cm	81 cm	81 cm	81 cm
<b>Sitzhöhe</b> / Seat height / Hauteur de siège / Zithoogte	41 cm	41 cm	41 cm	41 cm	41 cm
<b>Sitztiefe</b> / Seat depth / Profondeur siège / Zitdiepte	53 cm	53 cm	53 cm	53 cm	53 cm
<b>Sitztiefe 62 cm / 10% Aufpreis</b>					
Seat depth Surcharge / Profondeur siège Supplément					
Zitdiepte Meerprijs					
<b>Bestell-Nr.</b> / Order no. / N° de commande / Ordernu.	<b>D330.14</b>	<b>D330.25</b>	<b>D330.26</b>	<b>D330.27</b>	<b>D330.28</b>
<b>Stoffgruppe</b>	12	<b>1375</b>	<b>2175</b>	<b>2275</b>	<b>2475</b>
Fabric category	13	<b>1425</b>	<b>2225</b>	<b>2325</b>	<b>2550</b>
Catégorie de tissu	14	<b>1450</b>	<b>2275</b>	<b>2375</b>	<b>2575</b>
Stofgroep	15	<b>1475</b>	<b>2325</b>	<b>2425</b>	<b>2650</b>
	16	<b>1495</b>	<b>2375</b>	<b>2475</b>	<b>2695</b>
	17	<b>1575</b>	<b>2450</b>	<b>2550</b>	<b>2795</b>
	18	<b>1595</b>	<b>2475</b>	<b>2575</b>	<b>2875</b>
	19	<b>1675</b>	<b>2675</b>	<b>2775</b>	<b>2975</b>
	20	<b>1775</b>	<b>2775</b>	<b>2875</b>	<b>3175</b>
<b>Avantgarde</b>		<b>1595</b>	<b>2475</b>	<b>2575</b>	<b>2875</b>
<b>Ledergruppe</b>	Derby	<b>1975</b>	<b>3175</b>	<b>3275</b>	<b>3575</b>
Leather category	Touch	<b>2075</b>	<b>3275</b>	<b>3475</b>	<b>3675</b>
Catégorie de cuir	Premium	<b>2175</b>	<b>3375</b>	<b>3575</b>	<b>3775</b>
Leergroep	Nature	<b>2375</b>	<b>3675</b>	<b>3775</b>	<b>4175</b>
	Imperial	<b>2575</b>	<b>3975</b>	<b>4075</b>	<b>4475</b>
<b>Preis bei Stoffzugabe</b>		<b>1275</b>	<b>2075</b>	<b>2175</b>	<b>2375</b>
Price in customer's own fabric					
Prix sans matériau de recouvrement					
Prijs bij eigen stof					
<b>Stoffbedarf, ohne Rapport</b>					
Fabric requirement, without pattern					
Métrage de tissu nécessaire, sans raccord					
Benodigde bekledingsstof zonder rapport					
<b>140 cm breit</b> / wide / large / breedte	4,75 m	7,30 m	7,60 m	8,30 m	9,20 m
<b>130 cm breit</b> / wide / large / breedte	5,00 m	8,10 m	8,40 m	9,20 m	10,40 m

<b>Sitztiefe bitte bei der Bestellung unbedingt angeben.</b> Important - Specify seat depth in your order. Veuillez absolument indiquer à la commande la profondeur de siège. Gelieve de zitdiepte bij de bestelling te vermelden.					
					
	Anreihelement links	Anreihelement rechts	Anreihsofa links 2-sitzig	Anreihsofa rechts 2-sitzig	Anreihsofa links 2 1/2-sitzig
<b>Breite</b> / Width / Largeur / Breedte	81 cm	81 cm	156 cm	156 cm	166 cm
<b>Tiefe</b> / Depth / Profondeur / Diepte	84 cm	84 cm	84 cm	84 cm	84 cm
<b>Höhe</b> / Height / Hauteur / Hoogte	81 cm	81 cm	81 cm	81 cm	81 cm
<b>Sitzhöhe</b> / Seat height / Hauteur de siège / Zithoogte	41 cm	41 cm	41 cm	41 cm	41 cm
<b>Sitztiefe</b> / Seat depth / Profondeur siège / Zitdiepte	53 cm	53 cm	53 cm	53 cm	53 cm
<b>Sitztiefe 62 cm / 10% Aufpreis</b>					
Seat depth Surcharge / Profondeur siège Supplément					
Zitdiepte Meerprijs					
<b>Bestell-Nr.</b> / Order no. / N° de commande / Ordernu.	<b>D330.41 L</b>	<b>D330.41 R</b>	<b>D330.46 L</b>	<b>D330.46 R</b>	<b>D330.47 L</b>
<b>Stoffgruppe</b>	12	<b>1250</b>	<b>1250</b>	<b>1875</b>	<b>1875</b>
Fabric category	13	<b>1295</b>	<b>1295</b>	<b>1925</b>	<b>1925</b>
Catégorie de tissu	14	<b>1325</b>	<b>1325</b>	<b>1975</b>	<b>2150</b>
Stofgroep	15	<b>1350</b>	<b>1350</b>	<b>2025</b>	<b>2195</b>
	16	<b>1375</b>	<b>1375</b>	<b>2050</b>	<b>2250</b>
	17	<b>1425</b>	<b>1425</b>	<b>2125</b>	<b>2325</b>
	18	<b>1450</b>	<b>1450</b>	<b>2175</b>	<b>2375</b>
	19	<b>1525</b>	<b>1525</b>	<b>2295</b>	<b>2475</b>
	20	<b>1575</b>	<b>1575</b>	<b>2375</b>	<b>2575</b>
<b>Avantgarde</b>		<b>1450</b>	<b>1450</b>	<b>2175</b>	<b>2375</b>
<b>Ledergruppe</b>	Derby	<b>1675</b>	<b>1675</b>	<b>2675</b>	<b>2975</b>
Leather category	Touch	<b>1775</b>	<b>1775</b>	<b>2775</b>	<b>3075</b>
Catégorie de cuir	Premium	<b>1875</b>	<b>1875</b>	<b>2875</b>	<b>3175</b>
Leergroep	Nature	<b>2075</b>	<b>2075</b>	<b>3175</b>	<b>3475</b>
	Imperial	<b>2275</b>	<b>2275</b>	<b>3475</b>	<b>3775</b>
<b>Preis bei Stoffzugabe</b>		<b>1150</b>	<b>1150</b>	<b>1775</b>	<b>1975</b>
Price in customer's own fabric					
Prix sans matériau de recouvrement					
Prijs bij eigen stof					
<b>Stoffbedarf, ohne Rapport</b>					
Fabric requirement, without pattern					
Métrage de tissu nécessaire, sans raccord					
Benodigde bekledingsstof zonder rapport					
<b>140 cm breit</b> / wide / large / breedte		4,20 m	4,20 m	6,20 m	6,20 m
<b>130 cm breit</b> / wide / large / breedte		4,40 m	4,40 m	6,90 m	6,90 m



<b>Sitztiefe bitte bei der Bestellung unbedingt angeben.</b> Important - Specify seat depth in your order. Veuillez absolument indiquer à la commande la profondeur de siège. Gelieve de zitdiepte bij de bestelling te vermelden.					
					
	Longchair links	Longchair rechts	Eckelement	Eckelement links 62 cm	Eckelement rechts 62 cm
<b>Breite</b> / Width / Largeur / Breedte	91 cm	91 cm	100 cm	100 cm	100 cm
<b>Tiefe</b> / Depth / Profondeur / Diepte	180 cm	180 cm	100 cm	100 cm	100 cm
<b>Höhe</b> / Height / Hauteur / Hoogte	81 cm	81 cm	81 cm	81 cm	81 cm
<b>Sitzhöhe</b> / Seat height / Hauteur de siège / Zithoogte	41 cm	41 cm	41 cm	41 cm	41 cm
<b>Sitztiefe</b> / Seat depth / Profondeur siège / Zitdiepte	149 cm	149 cm	53 cm	62 + 53 cm	53 + 62 cm
<b>Sitztiefe 62 cm / 10% Aufpreis</b>					
Seat depth Surcharge / Profondeur siège Supplément					
Zitdiepte Meerprijs					
<b>Bestell-Nr.</b> / Order no. / N° de commande / Ordernu.	<b>D330.79 L</b>	<b>D330.79 R</b>	<b>D330.70</b>	<b>D330.76 L</b>	<b>D330.76 R</b>
<b>Stoffgruppe</b>	12	<b>1695</b>	<b>1695</b>	<b>1425</b>	<b>1525</b>
Fabric category	13	<b>1750</b>	<b>1750</b>	<b>1475</b>	<b>1575</b>
Catégorie de tissu	14	<b>1795</b>	<b>1795</b>	<b>1495</b>	<b>1595</b>
Stofgroep	15	<b>1825</b>	<b>1825</b>	<b>1550</b>	<b>1650</b>
	16	<b>1850</b>	<b>1850</b>	<b>1595</b>	<b>1695</b>
	17	<b>1925</b>	<b>1925</b>	<b>1650</b>	<b>1750</b>
	18	<b>1975</b>	<b>1975</b>	<b>1695</b>	<b>1795</b>
	19	<b>2050</b>	<b>2050</b>	<b>1795</b>	<b>1895</b>
	20	<b>2095</b>	<b>2095</b>	<b>1875</b>	<b>1975</b>
<b>Avantgarde</b>		<b>1975</b>	<b>1975</b>	<b>1695</b>	<b>1795</b>
<b>Ledergruppe</b>	Derby	<b>2375</b>	<b>2375</b>	<b>1975</b>	<b>2075</b>
Leather category	Touch	<b>2475</b>	<b>2475</b>	<b>2075</b>	<b>2175</b>
Catégorie de cuir	Premium	<b>2575</b>	<b>2575</b>	<b>2175</b>	<b>2275</b>
Leergroep	Nature	<b>2875</b>	<b>2875</b>	<b>2475</b>	<b>2575</b>
	Imperial	<b>3175</b>	<b>3175</b>	<b>2675</b>	<b>2775</b>
<b>Preis bei Stoffzugabe</b>		<b>1595</b>	<b>1595</b>	<b>1325</b>	<b>1425</b>
Price in customer's own fabric					
Prix sans matériau de recouvrement					
Prijs bij eigen stof					
<b>Stoffbedarf, ohne Rapport</b>					
Fabric requirement, without pattern					
Métrage de tissu nécessaire, sans raccord					
Benodigde bekledingsstof zonder rapport					
<b>140 cm breit</b> / wide / large / breedte	5,20 m	5,20 m	5,70 m	5,80 m	5,80 m
<b>130 cm breit</b> / wide / large / breedte	5,60 m	5,60 m	5,85 m	5,95 m	5,95 m



<b>Sitztiefe bitte bei der Bestellung unbedingt angeben.</b> Important - Specify seat depth in your order. Veuillez absolument indiquer à la commande la profondeur de siège. Gelieve de zitdiepte bij de bestelling te vermelden.						
						
	runde Kopfstütze für Longchair 66 cm	runde Kopfstütze für Kissenbreite 73 cm	runde Kopfstütze für Kissenbreite 78 cm	runde Kopfstütze für Kissenbreite 87 cm	Spitzkissen 40 x 40 cm	
<b>Breite</b> / Width / Largeur / Breedte	66 cm	73 cm	78 cm	87 cm	40 x 40 cm	
<b>Tiefe</b> / Depth / Profondeur / Diepte	18 cm	18 cm	18 cm	18 cm	-	
<b>Höhe</b> / Height / Hauteur / Hoogte	18 cm	18 cm	18 cm	18 cm	-	
<b>Sitzhöhe</b> / Seat height / Hauteur de siège / Zithoogte	-	-	-	-	-	
<b>Sitztiefe</b> / Seat depth / Profondeur siège / Zitdiepte	-	-	-	-	-	
<b>Sitztiefe 62 cm / 10% Aufpreis</b>						
Seat depth Surcharge / Profondeur siège Supplément						
Zitdiepte Meerprijs						
<b>Bestell-Nr.</b> / Order no. / N° de commande / Ordernu.	<b>D330.82</b>	<b>D330.83</b>	<b>D330.84</b>	<b>D330.85</b>	<b>D330.900</b>	
<b>Stoffgruppe</b>	12	<b>185</b>	<b>195</b>	<b>205</b>	<b>225</b>	<b>55</b>
Fabric category	13	<b>195</b>	<b>205</b>	<b>215</b>	<b>235</b>	<b>65</b>
Catégorie de tissu	14	<b>200</b>	<b>210</b>	<b>220</b>	<b>240</b>	<b>70</b>
Stofgroep	15	<b>205</b>	<b>215</b>	<b>225</b>	<b>245</b>	<b>75</b>
	16	<b>210</b>	<b>220</b>	<b>230</b>	<b>250</b>	<b>80</b>
	17	<b>215</b>	<b>225</b>	<b>235</b>	<b>255</b>	<b>85</b>
	18	<b>225</b>	<b>235</b>	<b>245</b>	<b>265</b>	<b>90</b>
	19	<b>235</b>	<b>245</b>	<b>255</b>	<b>275</b>	<b>95</b>
	20	<b>245</b>	<b>255</b>	<b>265</b>	<b>285</b>	<b>95</b>
<b>Avantgarde</b>		<b>225</b>	<b>235</b>	<b>245</b>	<b>265</b>	<b>85</b>
<b>Ledergruppe</b>	Derby	<b>275</b>	<b>295</b>	<b>305</b>	<b>325</b>	<b>125</b>
Leather category	Touch	<b>275</b>	<b>295</b>	<b>305</b>	<b>325</b>	<b>125</b>
Catégorie de cuir	Premium	<b>295</b>	<b>305</b>	<b>325</b>	<b>350</b>	<b>155</b>
Leergroep	Nature	<b>325</b>	<b>350</b>	<b>375</b>	<b>395</b>	<b>175</b>
	Imperial	<b>350</b>	<b>375</b>	<b>395</b>	<b>425</b>	<b>195</b>
<b>Preis bei Stoffzugabe</b>		<b>185</b>	<b>195</b>	<b>205</b>	<b>225</b>	<b>55</b>
Price in customer's own fabric						
Prix sans matériau de recouvrement						
Prijs bij eigen stof						
<b>Stoffbedarf, ohne Rapport</b>						
Fabric requirement, without pattern						
Métrage de tissu nécessaire, sans raccord						
Benodigde bekledingsstof zonder rapport						
<b>140 cm breit</b> / wide / large / breedte		0,90 m	0,90 m	0,95 m	0,90 m	0,50 m
<b>130 cm breit</b> / wide / large / breedte		0,90 m	0,90 m	0,95 m	0,90 m	0,50 m



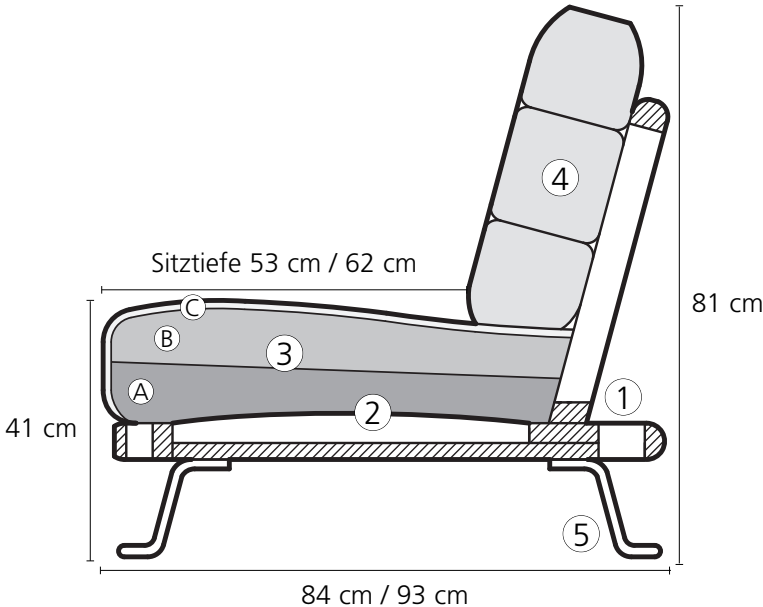

<b>Gestell</b>	Sitz- und Rückenrahmenkonstruktion Buche massiv, gedübelt und verleimt.	<b>Frame</b>	Seat and back frame construction solid beech, doweled and glued.
<b>Unterfederung</b>	Stahlwellenunterfederung	<b>Spring base</b>	Sinuuous spring base
<b>Sitzkissen</b>	Dreischichtiger Polsteraufbau <b>A</b> Polyätherschaum, RG 43 / 5,0 <b>B</b> Kaltschaum, RG 40 / 4,0 <b>C</b> Elastische Vliesabdeckung	<b>Seat cushions</b>	Three-layered cushion structure <b>A</b> Polyether foam, density 43 / 5.0 <b>B</b> Cold foam, density 40 / 4.0 <b>C</b> Elastic polyester padding
<b>Rückenkissen</b>	Lose Kammerkissen mit Daunencharakter, Füllung hochwertige Polyschaumstäbchen RG 28 (80%) und dauerelastischen Vliesfasern (20%).	<b>Back cushions</b>	Loose chambered cushions with a downy character. Filled with high-grade polyfoam sticks density 28 (80%) and permanent elastic polyester fibers (20%).
<b>Füsse</b>	Flachstahl	<b>Legs</b>	Flat steel
<b>Sitztiefen</b>	<b>53 cm, gegen Mehrpreis 62 cm Bei Bestellung bitte unbedingt angeben.</b>	<b>Seat depths</b>	<b>53 cm or 62 cm for an additional charge Please specify in your order.</b>
<b>Merkmale</b>	Sitzkissen geteilt Rückenkissen mit Seitenboden Nahtausführung Kappnaht, auch am Rückenkorpus seitlich Füsse unter den Armlehnen	<b>Special features</b>	Split seat cushion Back cushions with side reinforcement panels Flat-felled seams, also on the sides of the back frame Legs under the armrests

---

<b>Châssis</b>	Châssis d'assise et de dossier en hêtre massif, chevillé et collé. Assise et dossier vissés.	<b>Frame</b>	Zit- en ruggeraamte massief beuken, geplugd en vastgelijmd.
<b>Suspension</b>	Suspension en acier ondulé	<b>Vering</b>	Stalen springveren met speciale bekleding
<b>Coussins d'assise</b>	Rembourrage à trois couches <b>A</b> Mousse polyéther, RG 43 / 5,0 <b>B</b> Mousse à froid, RG 40 / 4,0 <b>C</b> Revêtement fibres de rembourrage élastique	<b>Zitkussens</b>	Drie-laags vering <b>A</b> Polyetherschium, RG 43 / 5,0 <b>B</b> Koud schuim, RG 40 / 4,0 <b>C</b> Elastische vliesbekleding
<b>Coussins de dossier</b>	Coussins capitonnés amovibles type duvet, rembourrage particules de mousse polyéther très résistante RG 28 (80%) et fibres polyester de rembourrage élastiques (20%).	<b>Rugkussens</b>	Losse kamerkussens met donskarakter, gevuld met een mengsel van zeer draagkrachtige polyschuimstaafjes RG 28 (80%) en vormelastische vliesvezels (20%).
<b>Pieds</b>	Acier plat	<b>Poten</b>	Platstaal
<b>Profondeurs d'assise</b>	<b>53 cm ou 62 cm avec supplément A préciser impérativement à la commande!</b>	<b>Zitdieptes</b>	<b>Standaard 53 cm, tegen meerprijs 62 cm Gelieve dit bij de bestelling duidelijk te specificeren.</b>
<b>Caractéristiques</b>	Coussins d'assise séparés Coussins de dossier avec partie latérale renforcée Couture à double rabattage, également sur les parties latérales du dossier. Pieds situés sous les accoudoirs	<b>Kenmerken</b>	Zitkussens gedeeld Rugkussens met zijbodem Naaduitvoering kapnaad, ook aan de rugromp zijkant Poten onder zijstukken

## Füsse / Legs / Pieds / Voeten



### D 10

Metall Flachstahl  
60 x 140 mm,  
**hochglanz verchromt**

Flat rolled steel metal foot  
60 x 140 mm,  
**highly polished chromium-plated**

### D 10

Pied en acier plat  
de 60 x 140 mm,  
**chromé brillant**

Metalen voet van platstaal,  
60 x 140 cm,  
**glanzend verchromd**



### D 10

Metall Flachstahl  
60 x 140 mm,  
**matt verchromt**  
Lackierung in allen RAL Farben gegen  
Aufpreis.

Flat rolled steel metal foot  
60 x 140 mm,  
**mat chromium-plated**  
Paint work in any RAL colour at extra  
charge.

### D 10

Pied en acier plat de 60 x 140 mm,  
**chromé mat**  
Laquage dans tous les coloris RAL  
moyennant supplément.

Metalen voet van platstaal,  
60 x 140 cm,  
**mat verchromd**  
Verlakkning in alle RAL-kleuren tegen  
meerprijs mogelijk.