

D240 My home

Produktumfang / Product range / Gamme des produits / productomvang

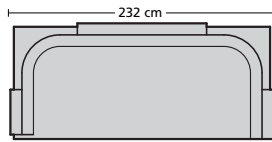

240.72 L

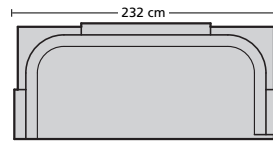

240.72 R

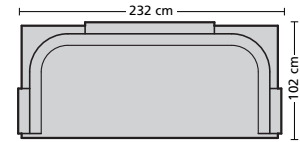

240.28
Sofa

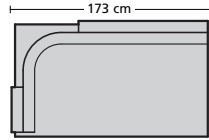

240.47 L

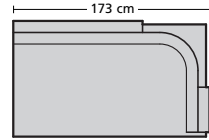

240.47 R

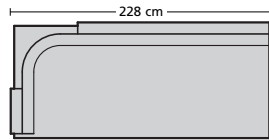

240.49 L

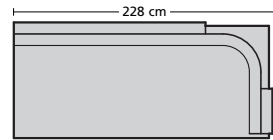

240.49 R

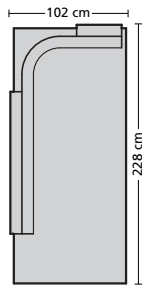

240.79 L

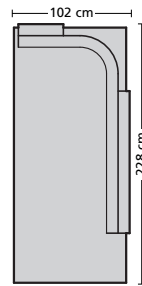

240.79 R

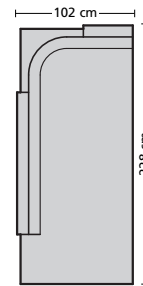

240.69 L

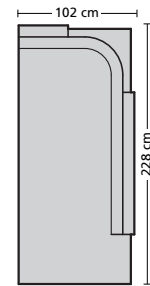

240.69 R

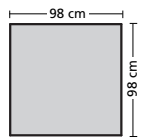

240.64
Hocker

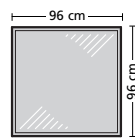

240.982
Hocker mit Tischablage



240.930
Rückenkissen

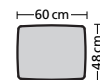

240.931
Rückenkissen

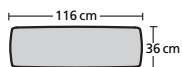

240.932
Rückenkissen

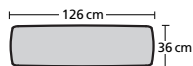

240.933
Rückenkissen

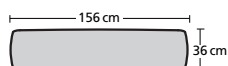

240.934
Rückenkissen

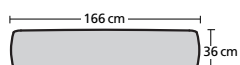

240.935
Rückenkissen

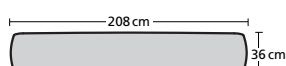

240.936
Rückenkissen

Rückenkissen bitte immer separat bestellen.

Please always order the back cushions separately.

Veillez toujours commander les coussins de dossie séparément.

Rugkussen steeds apart bestellen.

D240 My home

Kombinationsbeispiele / Arrangements

Exemples de composition / Combinatie voorbeelden

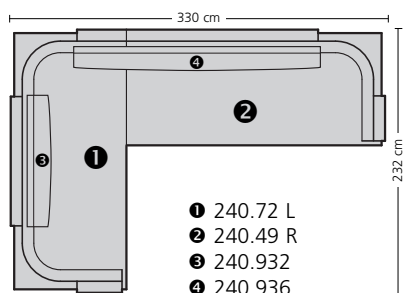
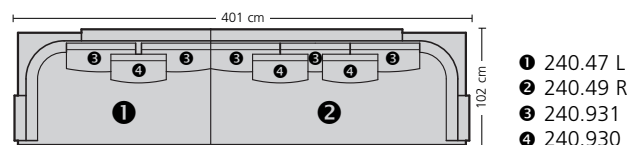
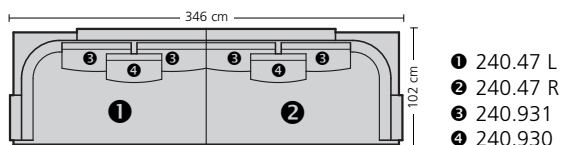
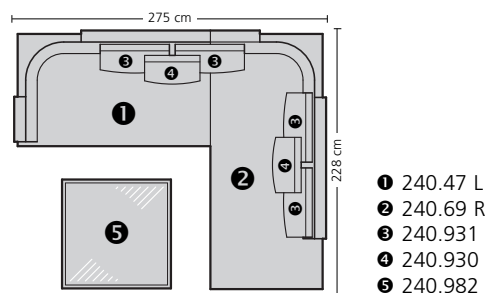
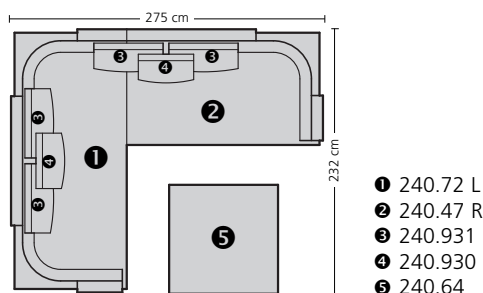
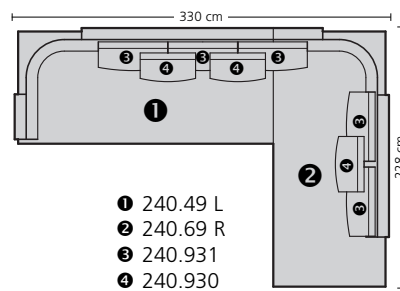
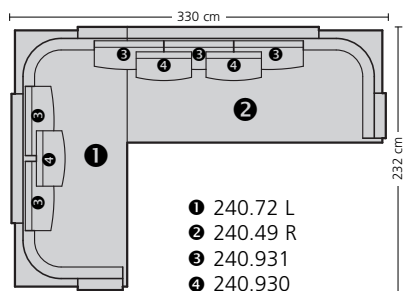



Durchgehende Rückenkissen bei D240 My home. Zuordnung zu den einzelnen Typen.

D240 My home comes with a continuous back cushion.
Possible cushion combinations for the different models.



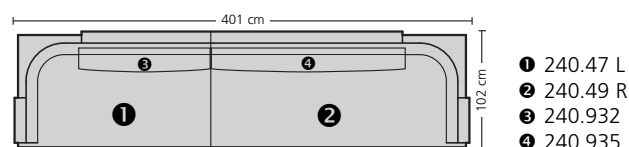
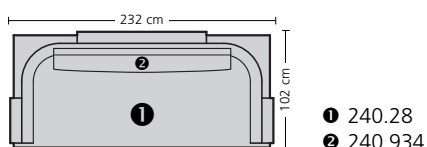
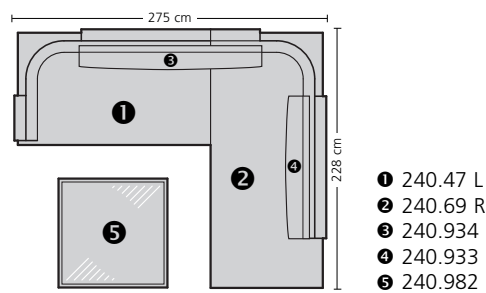
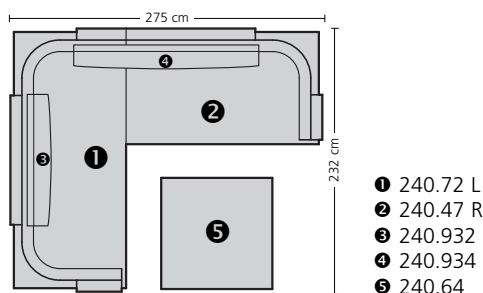

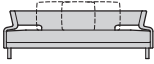
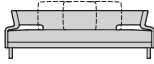
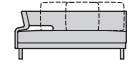
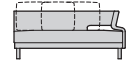
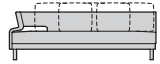
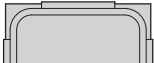
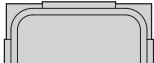
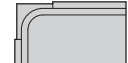
Coussins de dossier continus du modèle D240 My Home
Attribution aux différents types

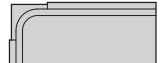
Doorlopend rugkussen uit één stuk bij D240 My home.
Indeling bij de afzonderlijke types.

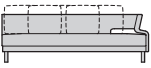
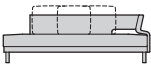
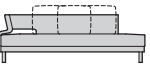
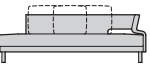
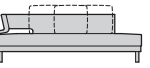
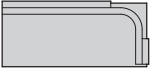
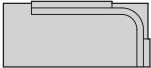
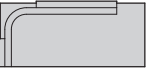
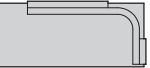
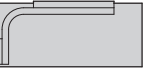

| |  |  |  |  |  |
|--|---|---|--|---|---|
| |  |  |  |  |  |
| | Anbausofa links | Anbausofa rechts | Anbausofa links 2-sitzig | Anbausofa rechts 2-sitzig | Anbausofa links 2 1/2-sitzig |
| Breite / Width / Largeur / Breedte | 232 cm | 232 cm | 173 cm | 173 cm | 228 cm |
| Tiefe / Depth / Profondeur / Diepte | 102 cm | 102 cm | 102 cm | 102 cm | 102 cm |
| Höhe / Height / Hauteur / Hoogte | 88 cm | 88 cm | 88 cm | 88 cm | 88 cm |
| Sitzhöhe / Seat height / Hauteur de siège / Zithoogte | 44 cm | 44 cm | 44 cm | 44 cm | 44 cm |
| Sitztiefe / Seat depth / Profondeur siège / Zitdiepte | 62 cm | 62 cm | 62 cm | 62 cm | 62 cm |
| Bestell-Nr. / Order no. / N° de commande / Ordernu. | D240.72 L | D240.72 R | D240.47 L | D240.47 R | D240.49 L |
| Stoffgruppe | 12 3575 | 13 3575 | 14 2675 | 15 2675 | 16 3275 |
| Fabric category | 13 3675 | 14 3675 | 15 2750 | 16 2750 | 17 3375 |
| Catégorie de tissu | 14 3725 | 15 3725 | 16 2775 | 17 2775 | 18 3425 |
| Stofgroep | 15 3750 | 16 3750 | 17 2825 | 18 2825 | 19 3450 |
| | 16 3775 | 17 3775 | 18 2875 | 19 2875 | 20 3475 |
| | 17 3875 | 18 3875 | 19 2925 | 20 2925 | 3575 |
| | 18 3975 | 19 3975 | 20 2975 | 2975 | 3675 |
| | 19 4175 | 20 4175 | 3175 | 3175 | 3775 |
| | 4275 | 4275 | 3275 | 3275 | 3875 |
| Avantgarde | 3975 | 3975 | 2975 | 2975 | 3675 |
| Ledergruppe | Derby 4575 | Touch 4575 | Premium 3475 | Nature 3475 | Imperial 4275 |
| Leather category | 4775 | 4775 | 3575 | 3575 | 4475 |
| Catégorie de cuir | 4875 | 4875 | 3775 | 3775 | 4575 |
| Leergroep | 5475 | 5475 | 4075 | 4075 | 5075 |
| | 5975 | 5975 | 4475 | 4475 | 5575 |
| Preis bei Stoffzugabe | 3475 | 3475 | 2575 | 2575 | 3175 |
| Price in customer's own fabric | | | | | |
| Prix sans matériau de recouvrement | | | | | |
| Prijs bij eigen stof | | | | | |
| Stoffbedarf, ohne Rapport | | | | | |
| Fabric requirement, without pattern | | | | | |
| Métrage de tissu nécessaire, sans raccord | | | | | |
| Benodigde bekledingsstof zonder rapport | | | | | |
| 140 cm breit / wide / large / breedte | 8,50 m | 8,50 m | 6,50 m | 6,50 m | 8,00 m |
| 130 cm breit / wide / large / breedte | 9,30 m | 9,30 m | 7,00 m | 7,00 m | 8,70 m |

| | | | | | | |
|--|----------|---|---|---|---|---|
| | |  |  |  |  |  |
| | |  |  |  |  |  |
| | | Anbausofa rechts 2 1/2-sitzig | Abschlusselement links | Abschlusselement rechts | Longchair links | Longchair rechts |
| Breite / Width / Largeur / Breedte | | 228 cm | 228 cm | 228 cm | 228 cm | 228 cm |
| Tiefe / Depth / Profondeur / Diepte | | 102 cm | 102 cm | 102 cm | 102 cm | 102 cm |
| Höhe / Height / Hauteur / Hoogte | | 88 cm | 88 cm | 88 cm | 88 cm | 88 cm |
| Sitzhöhe / Seat height / Hauteur de siège / Zithoogte | | 44 cm | 44 cm | 44 cm | 44 cm | 44 cm |
| Sitztiefe / Seat depth / Profondeur siège / Zitdiepte | | 62 cm | 62 cm | 62 cm | 62 cm | 62 cm |
| Bestell-Nr. / Order no. / N° de commande / Ordernu. | | D240.49 R | D240.69 L | D240.69 R | D240.79 L | D240.79 R |
| Stoffgruppe | 12 | 3275 | 2975 | 2975 | 2975 | 2975 |
| Fabric category | 13 | 3375 | 3075 | 3075 | 3075 | 3075 |
| Catégorie de tissu | 14 | 3425 | 3125 | 3125 | 3125 | 3125 |
| Stofgroep | 15 | 3450 | 3150 | 3150 | 3150 | 3150 |
| | 16 | 3475 | 3175 | 3175 | 3175 | 3175 |
| | 17 | 3575 | 3275 | 3275 | 3275 | 3275 |
| | 18 | 3675 | 3375 | 3375 | 3375 | 3375 |
| | 19 | 3775 | 3475 | 3475 | 3475 | 3475 |
| | 20 | 3875 | 3575 | 3575 | 3575 | 3575 |
| Avantgarde | | 3675 | 3375 | 3375 | 3375 | 3375 |
| Ledergruppe | Derby | 4275 | 3975 | 3975 | 3975 | 3975 |
| Leather category | Touch | 4475 | 4175 | 4175 | 4175 | 4175 |
| Catégorie de cuir | Premium | 4575 | 4275 | 4275 | 4275 | 4275 |
| Leergroep | Nature | 5075 | 4775 | 4775 | 4775 | 4775 |
| | Imperial | 5575 | 5275 | 5275 | 5275 | 5275 |
| Preis bei Stoffzugabe | | 3175 | 2875 | 2875 | 2875 | 2875 |
| Price in customer's own fabric | | | | | | |
| Prix sans matériau de recouvrement | | | | | | |
| Prijs bij eigen stof | | | | | | |
| Stoffbedarf, ohne Rapport | | | | | | |
| Fabric requirement, without pattern | | | | | | |
| Métrage de tissu nécessaire, sans raccord | | | | | | |
| Benodigde bekledingsstof zonder rapport | | | | | | |
| 140 cm breit / wide / large / breedte | | 8,00 m | 7,40 m | 7,40 m | 7,60 m | 7,60 m |
| 130 cm breit / wide / large / breedte | | 8,70 m | 8,10 m | 8,10 m | 8,10 m | 8,10 m |

| | | | | | | |
|--|---|---|---|---|---|--------|
| | | | | | | |
| |  |  |  |  |  | |
| | Rückenkissen | Rückenkissen | Rückenkissen | Rückenkissen | Rückenkissen | |
| Breite / Width / Largeur / Breedte | 116 x 36 x 12 cm | 126 x 36 x 12 cm | 156 x 36 x 12 cm | 166 x 36 x 12 cm | 208 x 36 x 12 cm | |
| Tiefe / Depth / Profondeur / Diepte | - | - | - | - | - | |
| Höhe / Height / Hauteur / Hoogte | - | - | - | - | - | |
| Sitzhöhe / Seat height / Hauteur de siège / Zithoogte | - | - | - | - | - | |
| Sitztiefe / Seat depth / Profondeur siège / Zitdiepte | - | - | - | - | - | |
| Bestell-Nr. / Order no. / N° de commande / Ordernu. | D240.932 | D240.933 | D240.934 | D240.935 | D240.936 | |
| Stoffgruppe | 12 | 215 | 235 | 285 | 345 | |
| Fabric category | 13 | 225 | 245 | 295 | 355 | |
| Catégorie de tissu | 14 | 235 | 265 | 315 | 395 | |
| Stofgroep | 15 | 245 | 275 | 325 | 405 | |
| | 16 | 265 | 295 | 345 | 425 | |
| | 17 | 275 | 305 | 355 | 435 | |
| | 18 | 295 | 325 | 375 | 475 | |
| | 19 | 335 | 375 | 425 | 525 | |
| | 20 | 385 | 425 | 475 | 575 | |
| Avantgarde | | 295 | 325 | 375 | 475 | |
| Ledergruppe | Derby | 425 | 475 | 575 | 695 | |
| Leather category | Touch | 450 | 495 | 595 | 725 | |
| Catégorie de cuir | Premium | 475 | 525 | 625 | 775 | |
| Leergroep | Nature | 575 | 625 | 750 | 925 | |
| | Imperial | 625 | 675 | 825 | 1025 | |
| Preis bei Stoffzugabe | | 195 | 225 | 275 | 335 | |
| Price in customer's own fabric | | | | | | |
| Prix sans matériau de recouvrement | | | | | | |
| Prijs bij eigen stof | | | | | | |
| Stoffbedarf, ohne Rapport | | | | | | |
| Fabric requirement, without pattern | | | | | | |
| Métrage de tissu nécessaire, sans raccord | | | | | | |
| Benodigde bekledingsstof zonder rapport | | | | | | |
| 140 cm breit / wide / large / breedte | | 1,30 m | 1,45 m | 1,75 m | 1,85 m | 2,30 m |
| 130 cm breit / wide / large / breedte | | 1,40 m | 1,50 m | 1,85 m | 1,95 m | 2,40 m |
| | | | | | | |
| | | | | | | |
| | | | | | | |
| | | | | | | |
| | | | | | | |
| | | | | | | |
| | | | | | | |
| | | | | | | |
| | | | | | | |
| | | | | | | |

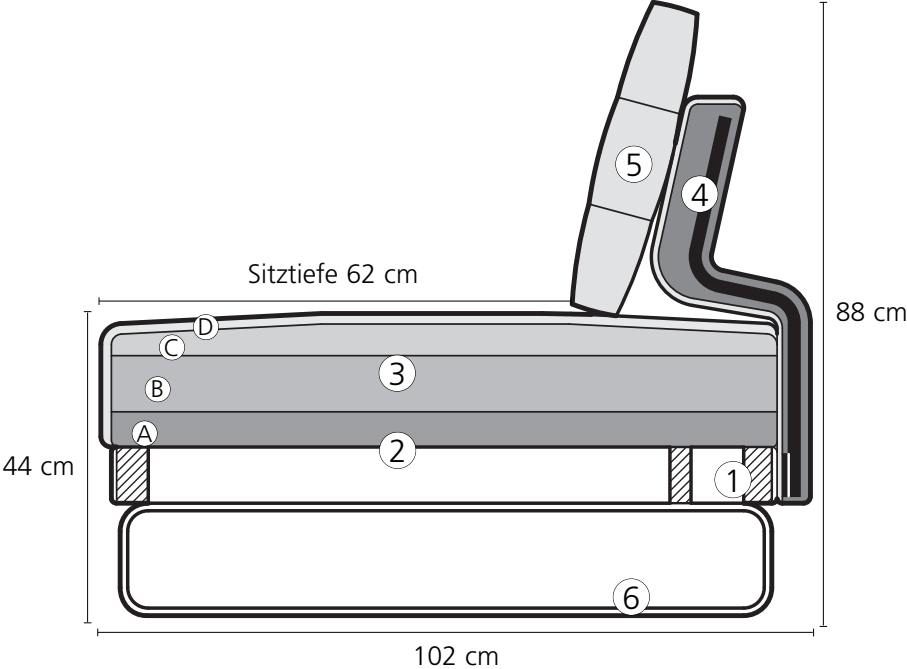

| | |
|----------------------|---|
| Gestell | Sitzrahmen Buche massiv, gedübelt und verleimt. |
| Unterfederung | Dauerelastisches Federungssystem |
| Sitzkissen | Vierschichtiger Polsteraufbau A Polyätherschaum, RG 39 / 5,0 B Kaltschaum RG 37 / 4,0 C Polyätherschaum, RG 37 / 1,3 D Vliesabdeckung |
| Rücken | Polyurethanweichschaum mit Stahlrohrkonstruktion |
| Fuss | Flachstahlkufe, hochglanz verchromt |
| Rückenkissen | Lose Kammerkissen mit Daunencharakter. Füllung hochwertige Polyätherschaumstäbchen RG 28 (80%) und Vliesfasern (20%) |

Rückenkissen bitte immer separat bestellen.

| | |
|----------------------|--|
| Frame | Seat frame solid beech, doweled and glued. |
| Spring base | Permanent elastic spring system |
| Seat cushions | Four-layered cushion structure A Polyether foam, density 39 / 5.0 B Cold foam, density 37 / 4.0 C Polyether foam, density 37 / 1.3 D Polyester padding |
| Back | Polyurethane flexible foam with tubular steel structure |
| Legs | Highly polished chromium-plated flat steel skids |
| Back cushions | Loose chambered cushions with a downy character. Filled with high-grade polyether foam sticks density 28 (80%) and polyester fibers (20%). |

Please always order the back cushions separately.

| | |
|----------------------------|---|
| Structure | Châssis d'assise en hêtre massif, chevillé et collé. |
| Suspension | Système de suspension élastique |
| Coussins d'assise | Rembouillage à quatre couches A Mousse polyéther, RG 39 / 5,0 B Mousse à froid RG 37 / 4,0 C Mousse polyéther, RG 37 / 1,3 D Revêtement polyester |
| Dossier | Mousse de polyuréthane souple avec structure en acier |
| Pied | Patin en acier plat, chromé brillant |
| Coussins de dossier | Coussins amovibles à finition alvéolée type duvet. Rembouillage à particules de mousse polyéther de haute qualité RG 28 (80%) et fibres polyester (20%) |

Veillez toujours commander les coussins de dossier séparément.

| | |
|--------------------|--|
| Onderstel | Zitframe massief beuken, verpend en gelijmd. |
| Ondervering | duurzaam elastisch veringsysteem |
| Zitkussen | vierlaags opbouw van de stoffering A Polyetherschuim, SG 39 / 5,0 B Koudschuim SG 37 / 4,0 C Polyetherschuim, SG 37 / 1,3 D Vliesafdekking |
| Rug | Polyurethaan zacht schuim met stalen buisconstructie |
| Voet | plat stalen voet, glanzend verchromd |
| Rugkussen | Los kamerkussen met donscharakter. Vulling hoogwaardige staafjes polyetherschuim SG 28 (80%) en vliesvezels (20%) |

Rugkussen steeds apart bestellen.